

中华人民共和国国家标准

半导体器件散热器 叉指形散热器

UDC 621.382

GB 7423.3—87

Heat sink of semiconductor devices
Heat sink, Staggered fingers shapes

本标准规定了叉指形散热器的型号编制方法、品种规格和技术要求。

叉指形散热器除应符合本标准的规定外，同时还应符合GB 7423.1—87《半导体器件散热器 通用技术条件》的规定。

1 叉指散热器型号的编制方法及标记示例

1.1 型号编制方法

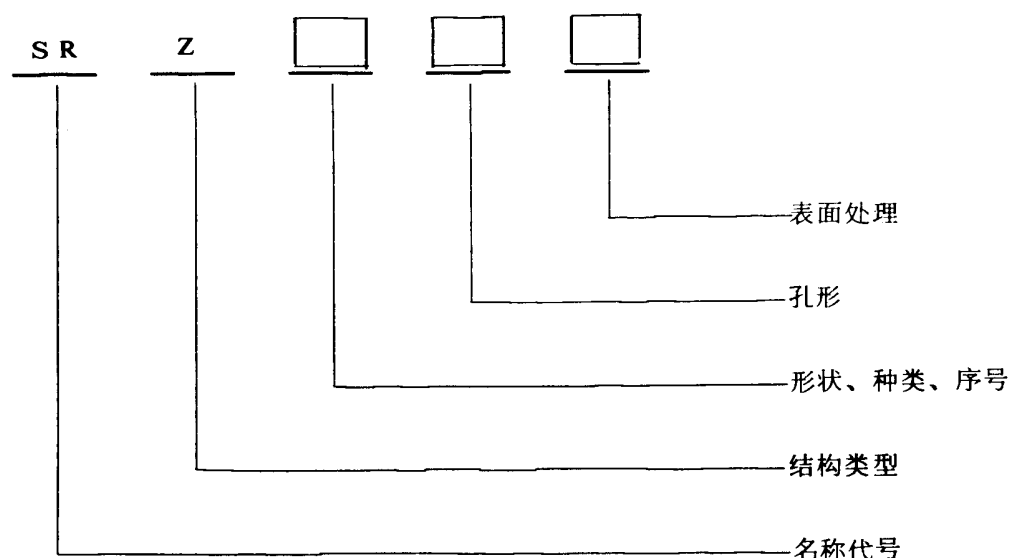

1.1.1 名称代号

SR分别表示“散”、“热”汉语拼音的首字母。

1.1.2 结构类型

Z表示叉指散热器中“指”字汉语拼音的首字母。

1.1.3 形状、种类、序号

用三位阿拉伯数字表示。第一位数字表示形状；第二位数字表示种类（见表1所示）；第三位数字表示种类序号，（A）表示一边不冲叉指的结构形状。

表 1

第一位数字	形 状	第二位数字	种 类
1	正方形	0	冲槽指
2	长方形	1	撕裂指
3	菱 形		
4	角 形		

1.1.4 孔形

散热器上安装器件用的孔形及代号，见图 1 所示。

1.2 标记示例

例 1：长方形撕裂指，一边不冲叉指，开 F_2 型孔形，散热器表面进行电化学氧化后着黑色处理，记为

SRZ213 (A) F_2 D · Y · Z · H

例 2：正方形冲槽指，不开孔形，散热器表面为化学氧化处理，记为

SRZ102 H · Y

2 品种规格

叉指散热器的品种、结构尺寸及其热性能特性曲线，见图 2 ~ 35 所示。

注：图中曲线（1）表示散热器仰放位置热阻曲线；曲线（2）表示散热器侧放位置热阻曲线。

3 技术要求

3.1 散热器的材料为铝板 L3 Y2 或 L4 Y2、L6 Y2，其技术条件应符合 YB 1701—77《铝及铝合金板》的要求。

3.2 散热器的热阻，应符合图 2 ~ 35 的规定。

3.3 散热器表面的粗糙度应符合 GB 1031—83《表面粗糙度参数及其数值》的规定，其表面不平度平均高度值不得超过 0.0032 mm。



图 1



图 2 SRZ 101
(理论重量6.6克)

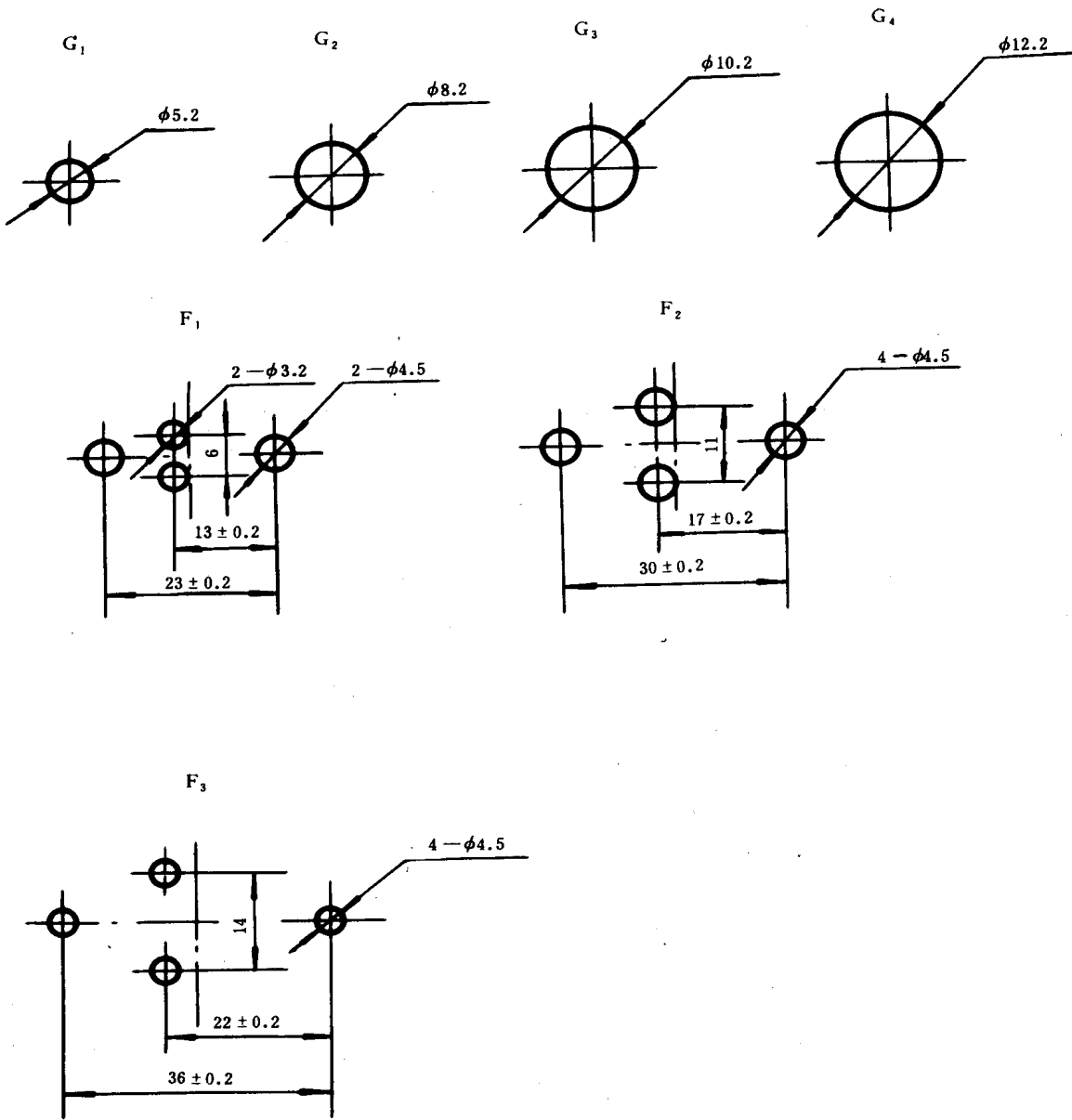

图 3 SRZ 102
(理论重量15.3克)



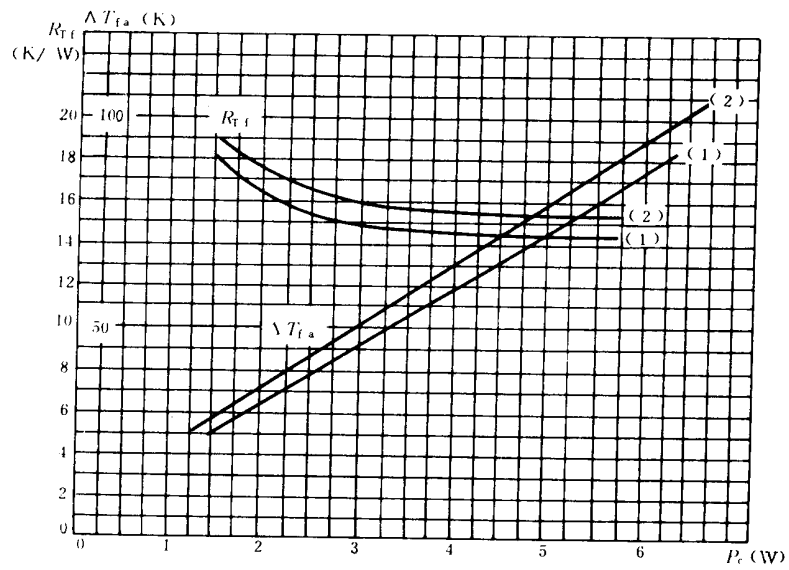
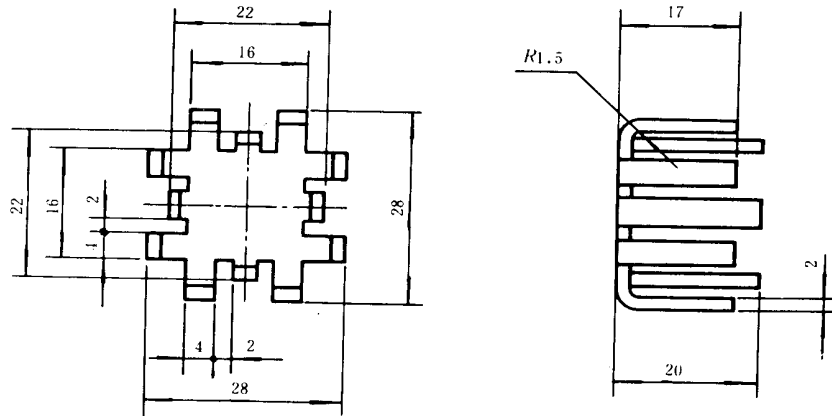

图 5 SRZ 104
(理论重量4.5克)

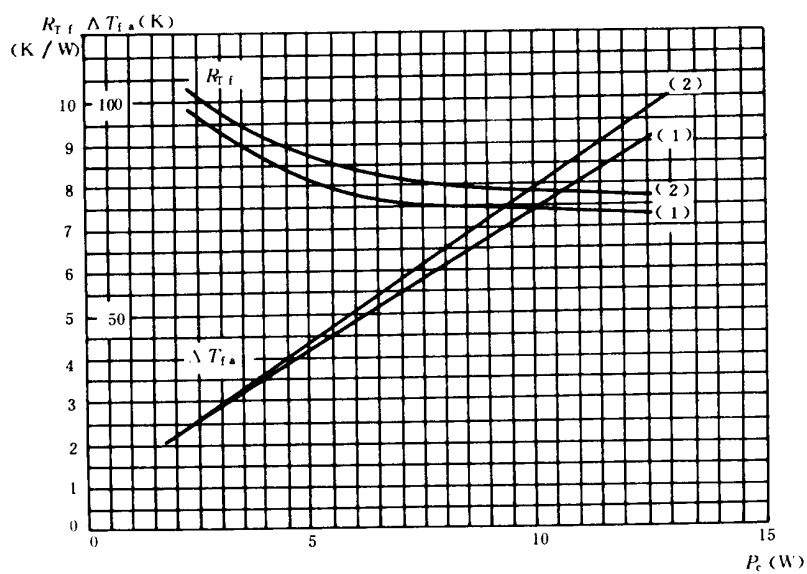
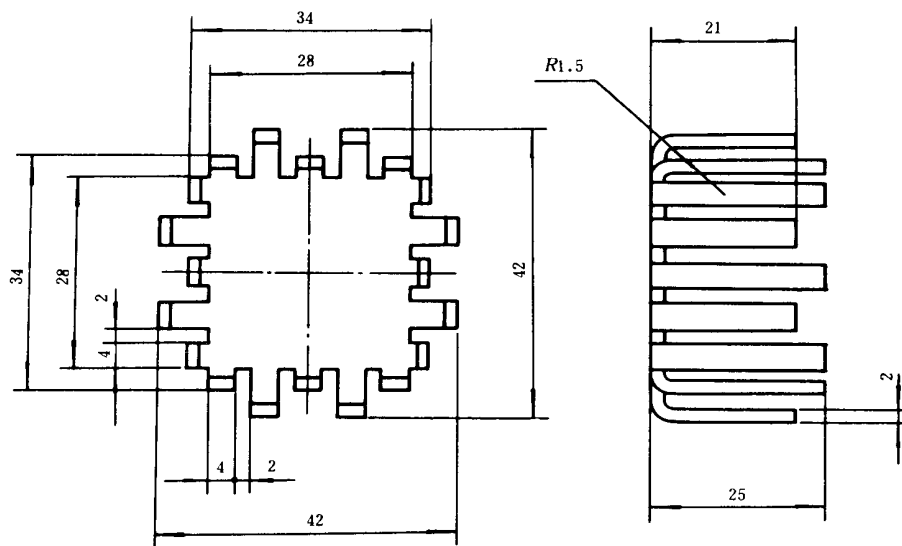
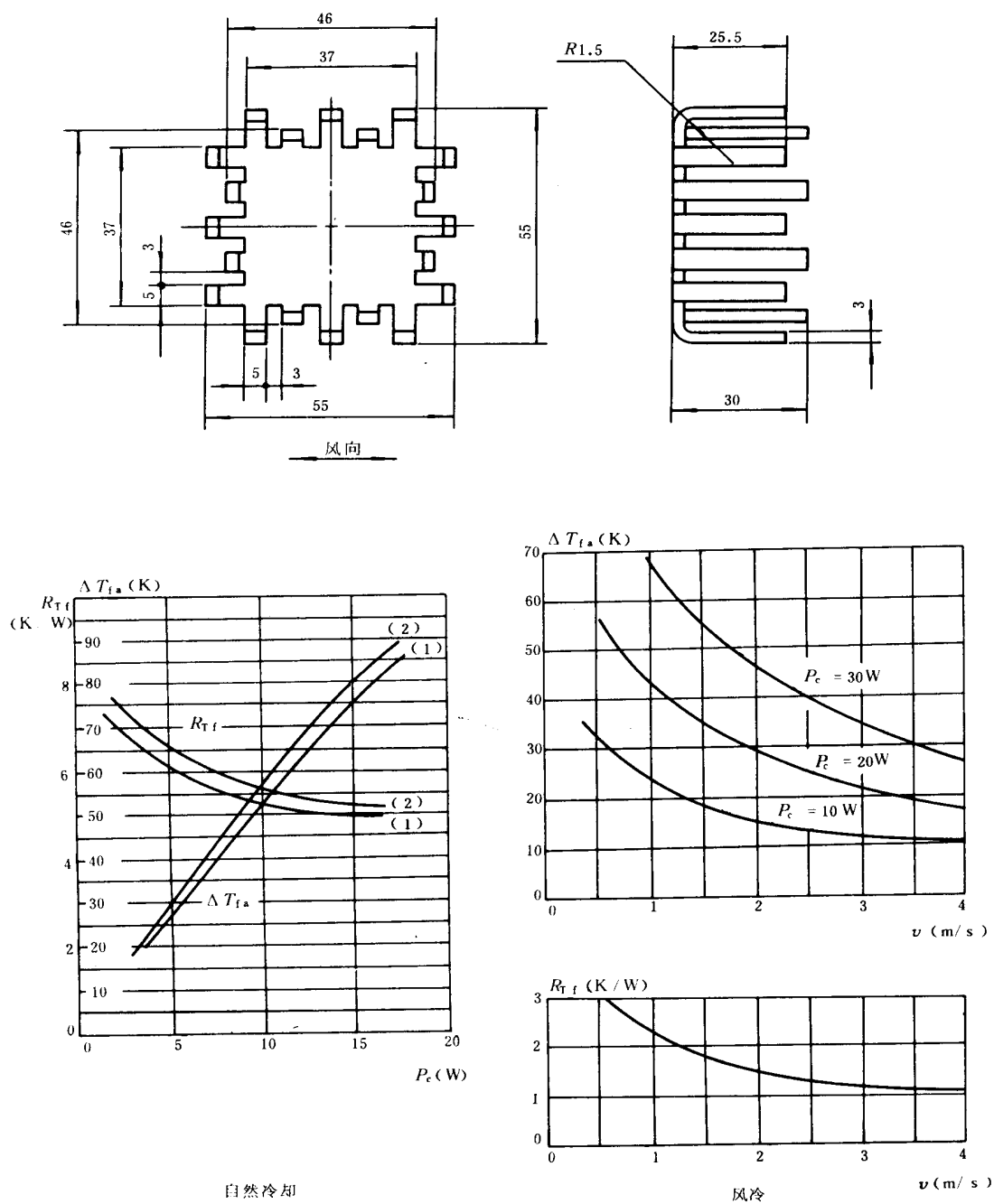

图 6 SRZ105
(理论重量57.6克)

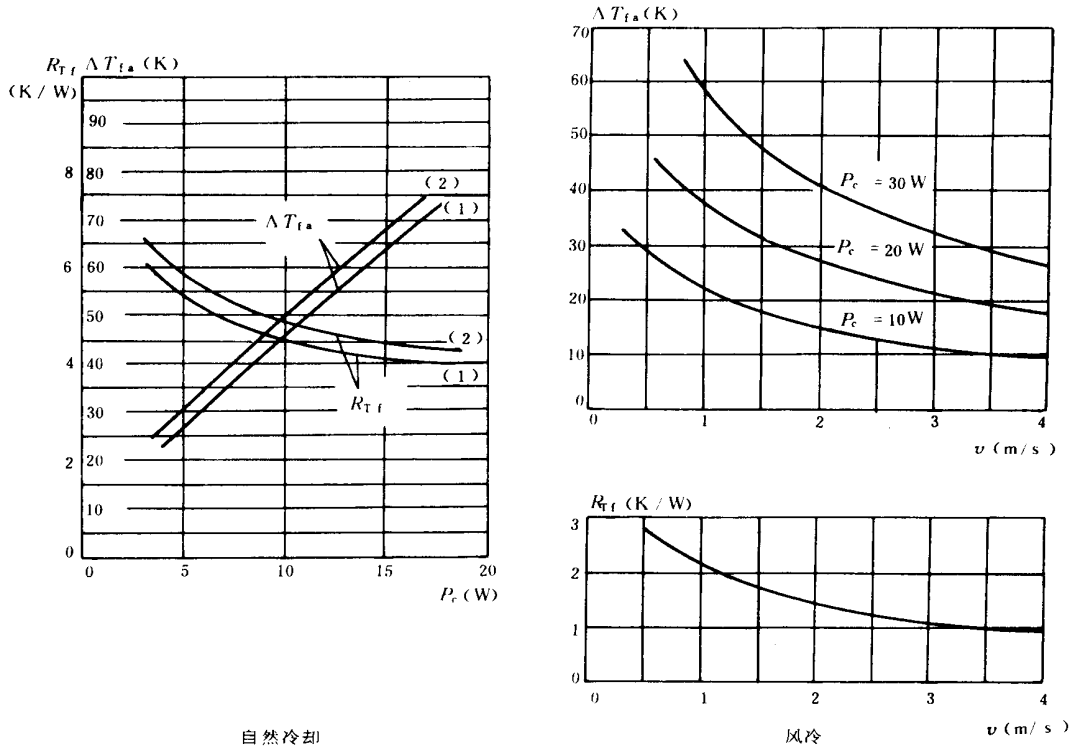
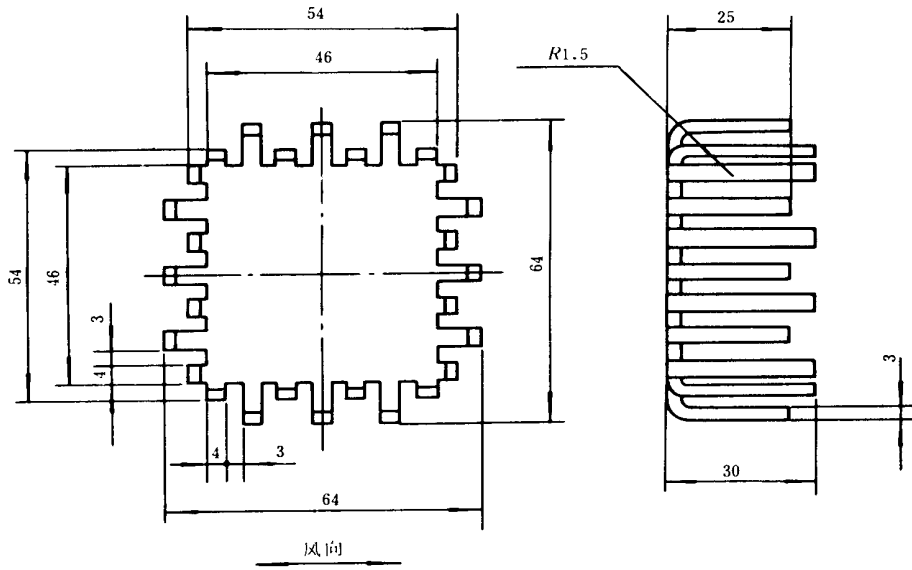

自然冷却

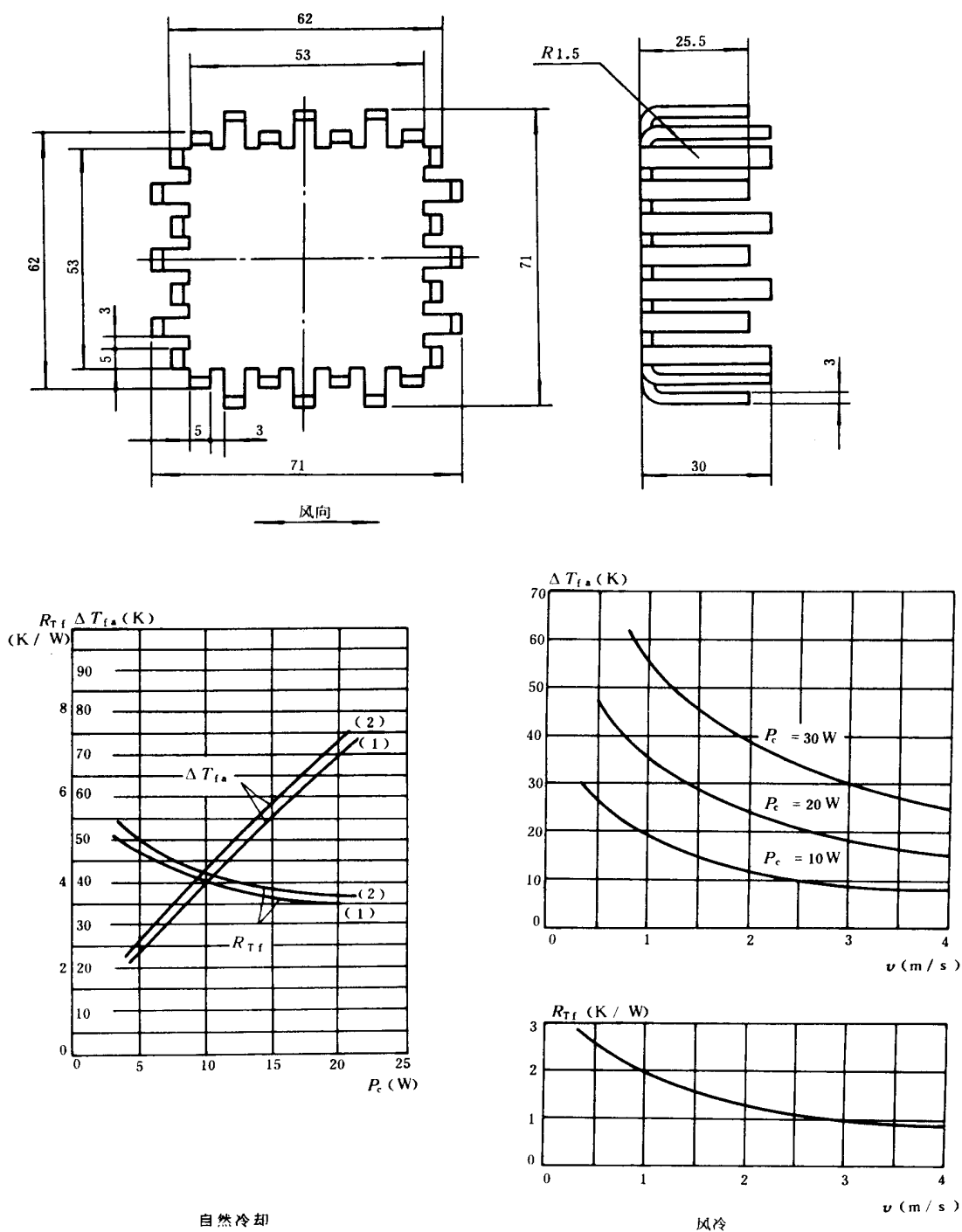
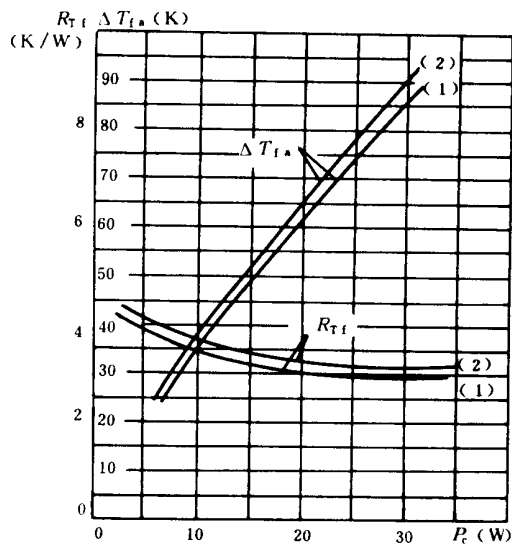
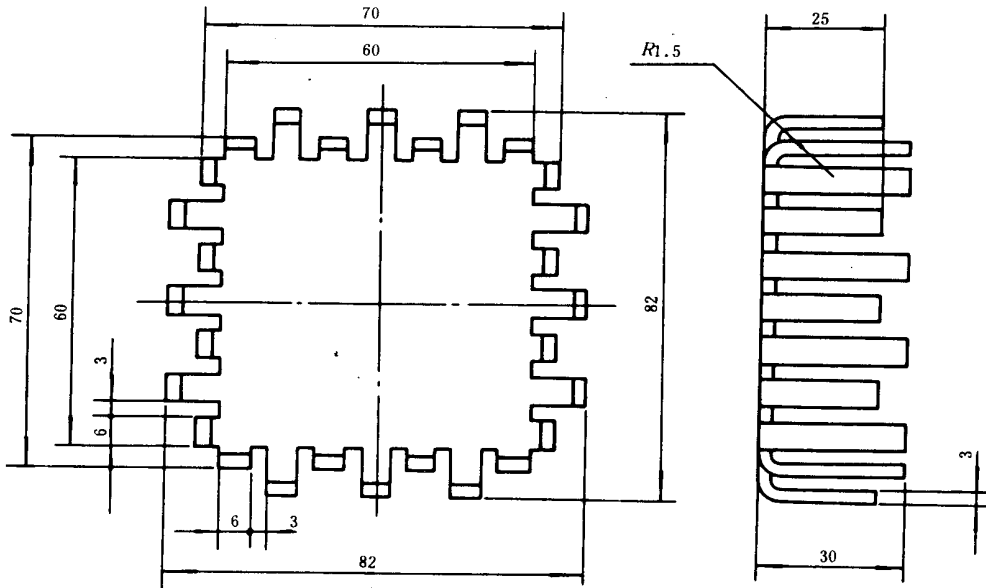
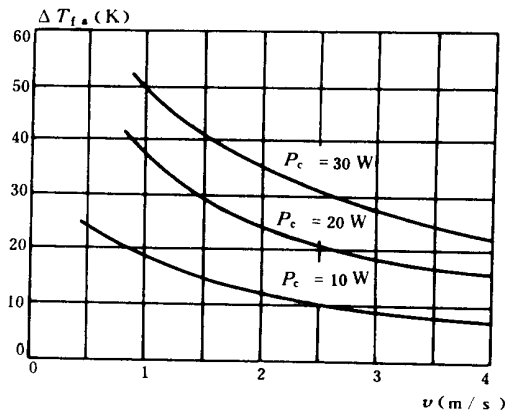

风冷



图 7 SRZ106
(理论重量70.9克)



图 8 SRZ111
(理论重量28.6克)

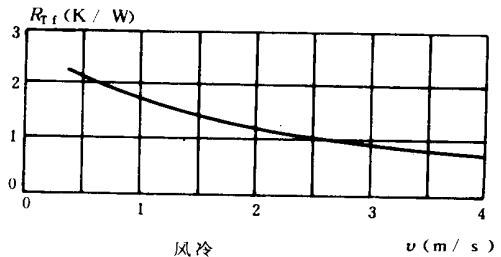

图 9 SRZ112
(理论重量33.5克)

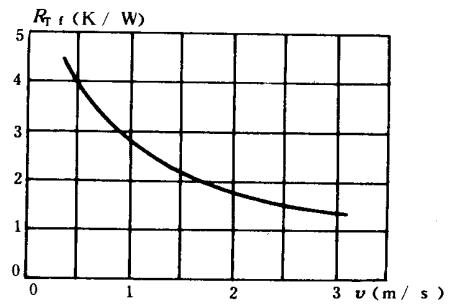
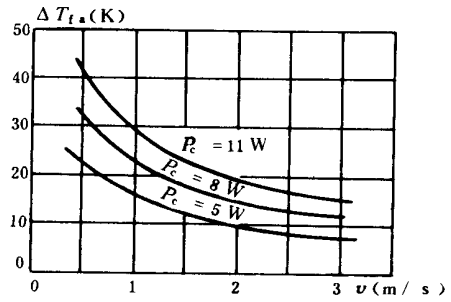
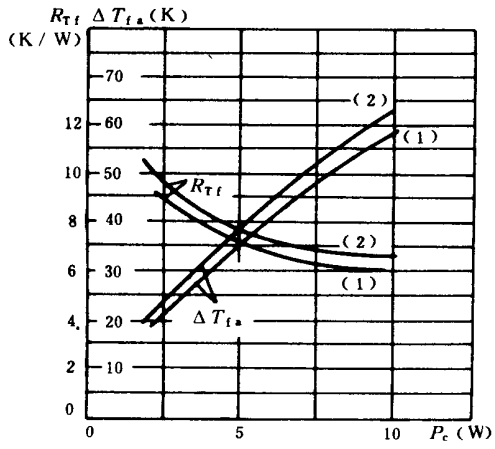
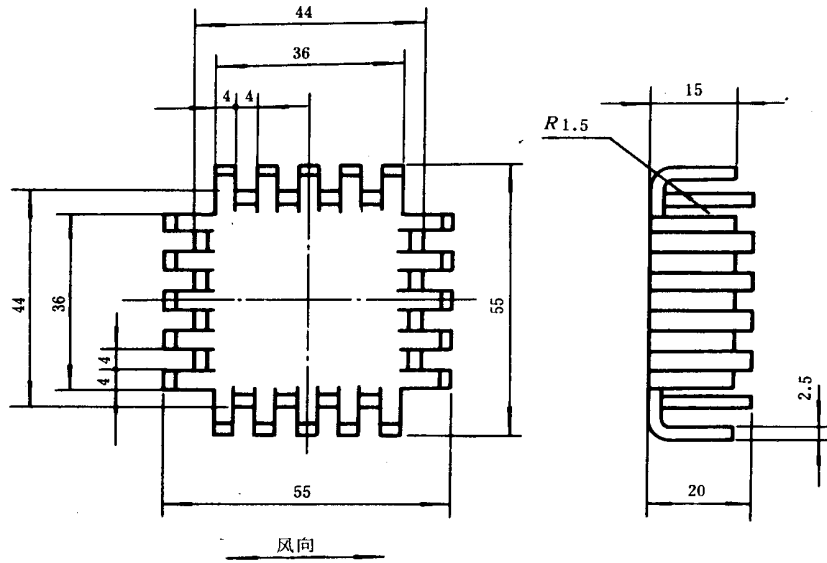

图 10 SRZ 113
(理论重量43.2克)

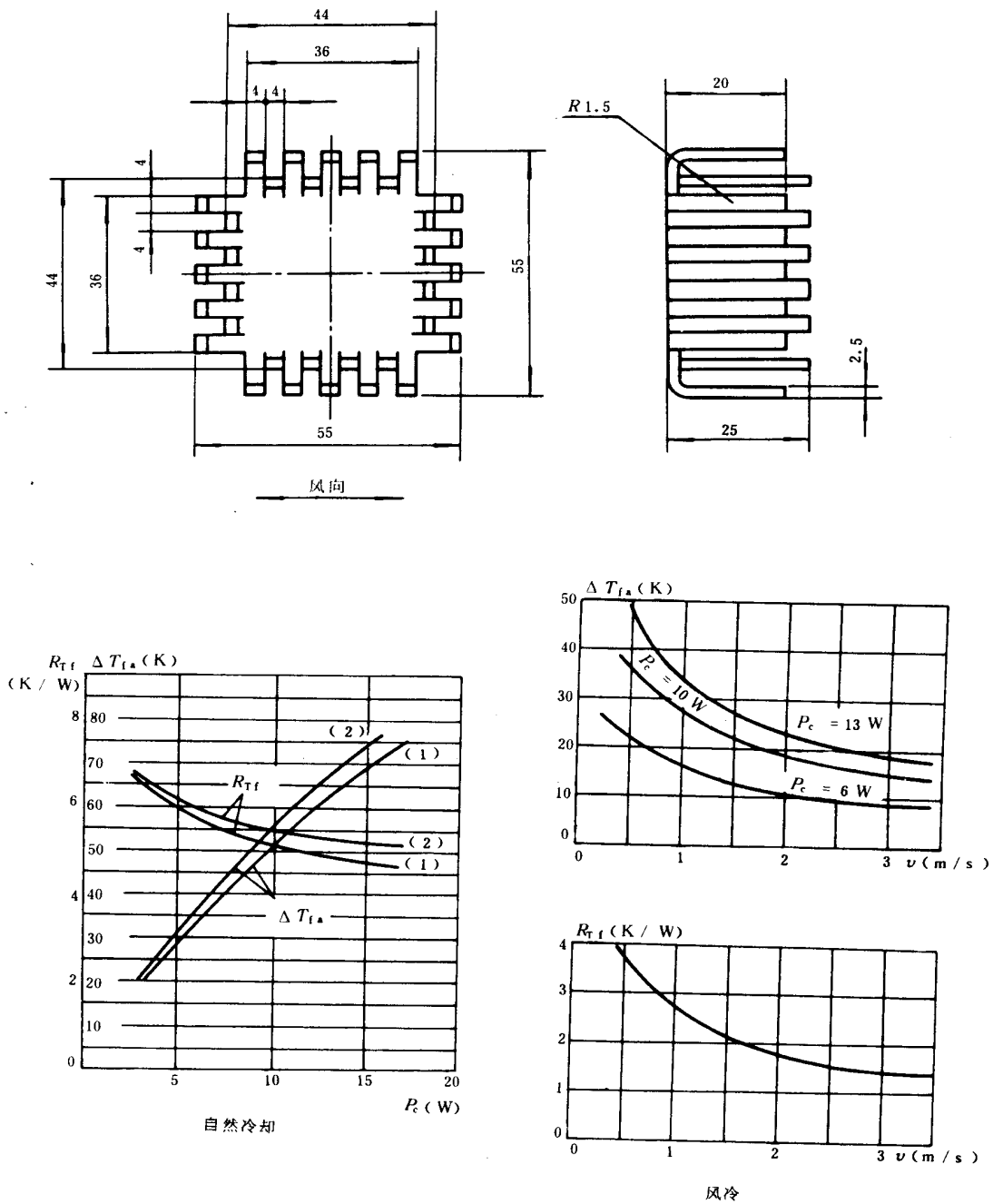

自然冷却

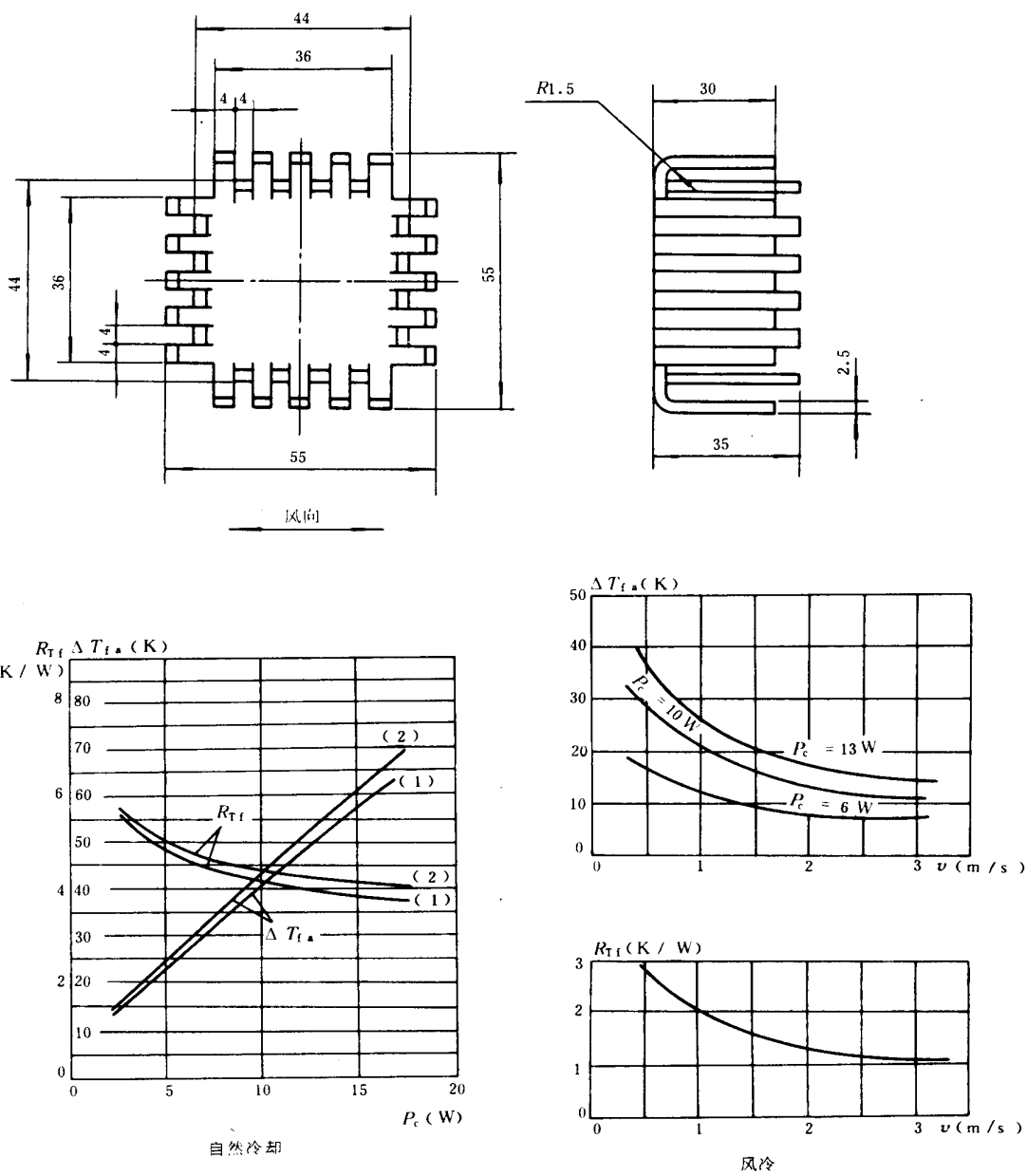
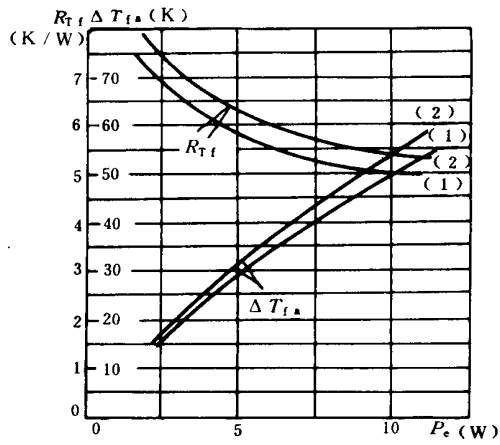
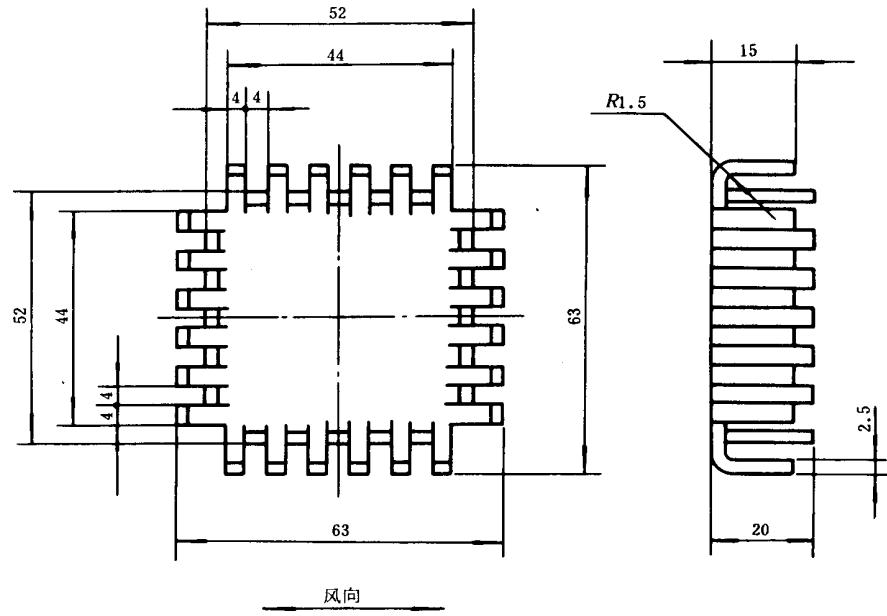
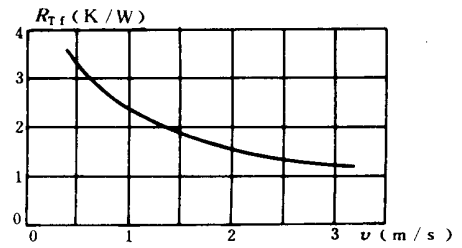
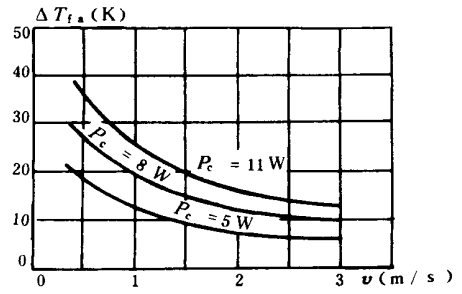

风冷

图 11 SRZ 114
(理论重量37.4克)



图 12 SRZ 115
(理论重量43.3克)



图 13 SRZ 116
(理论重量49.3克)

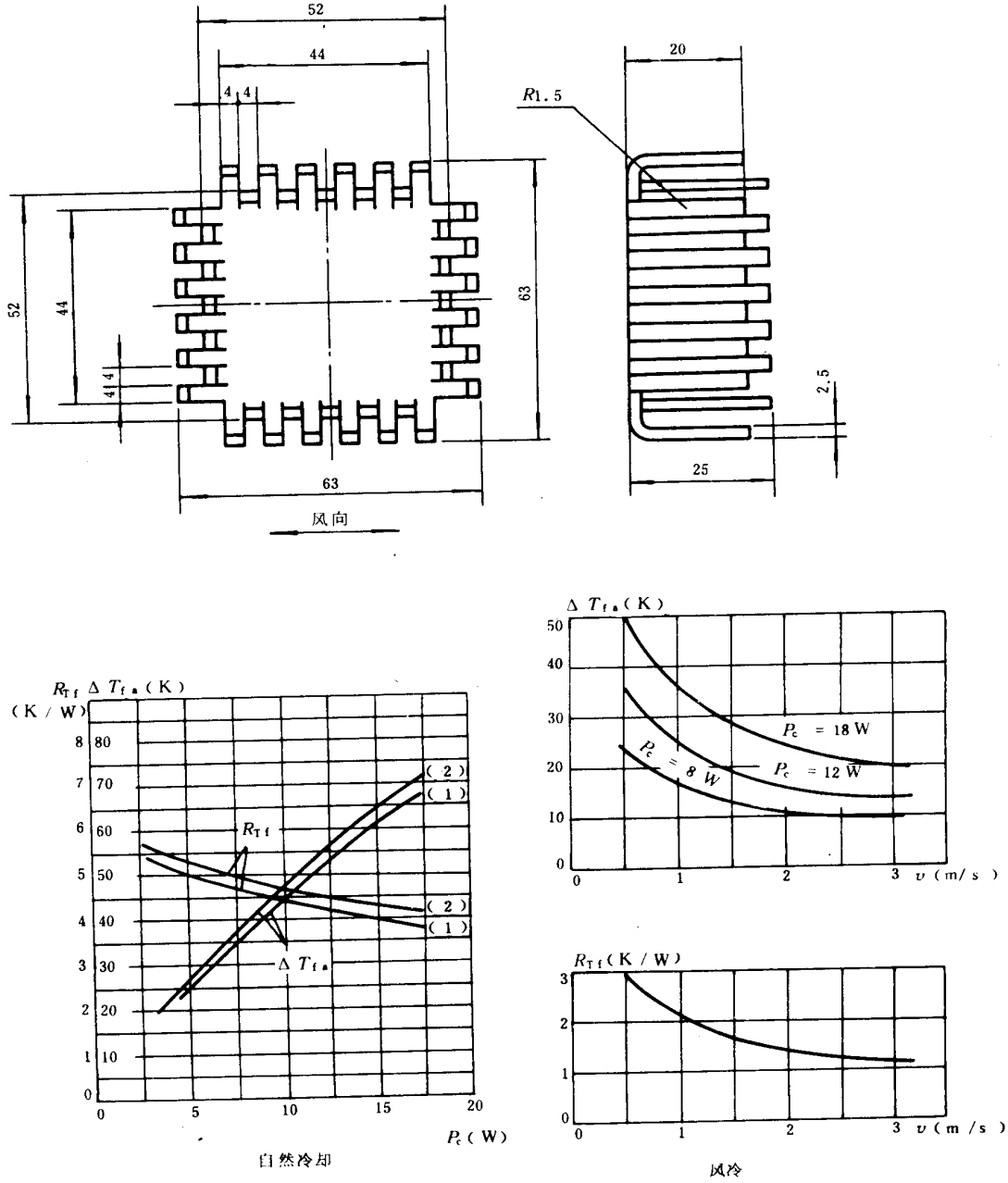

图 15 SRZ 118
(理论重量78.6克)

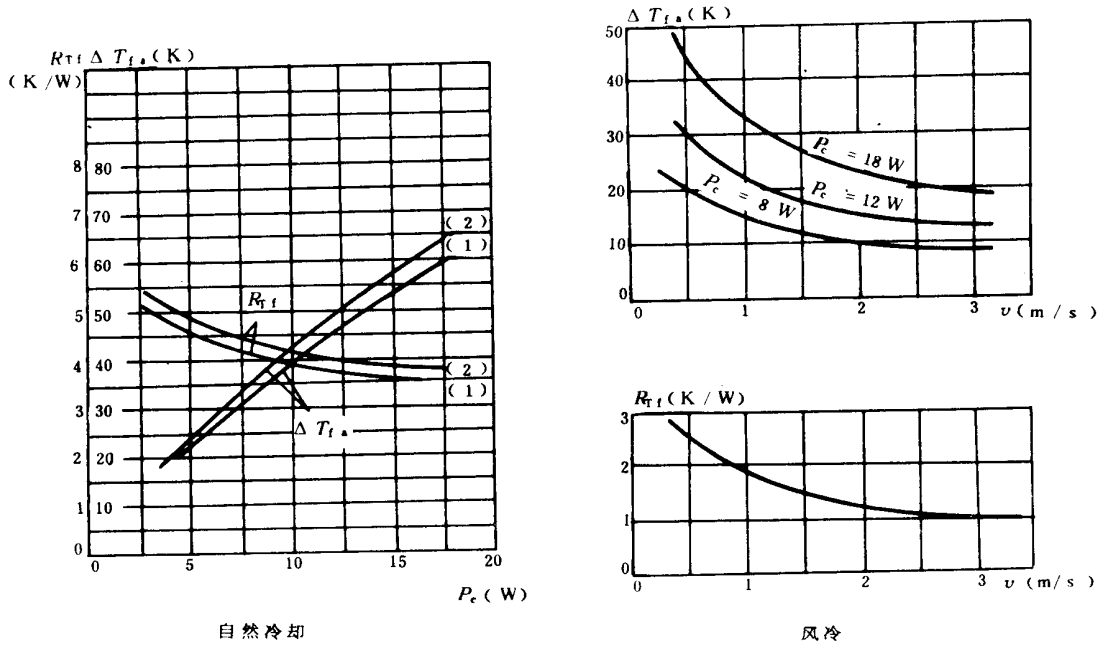
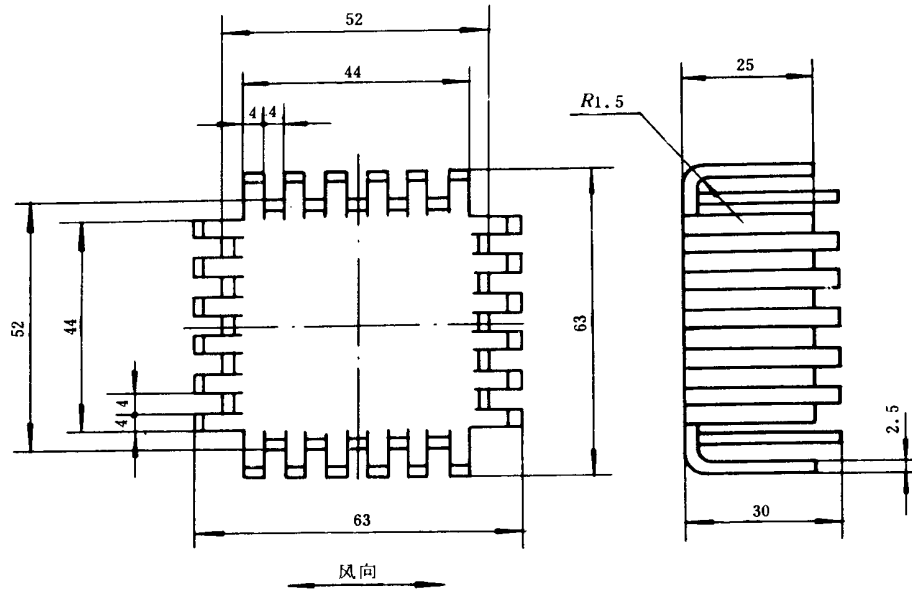

自然冷却

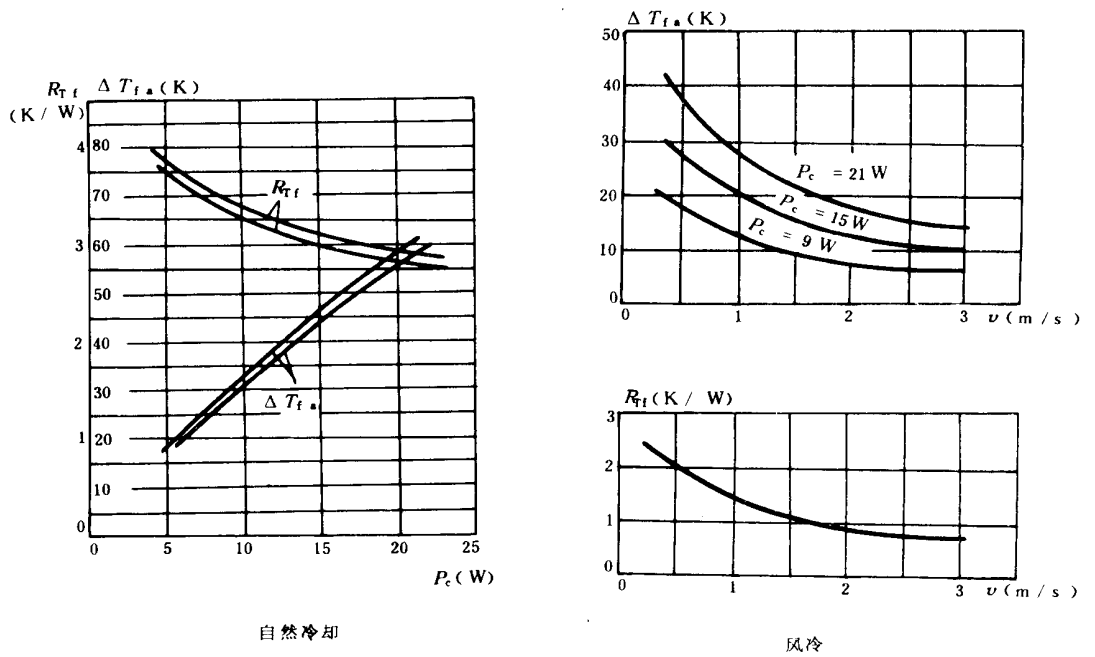
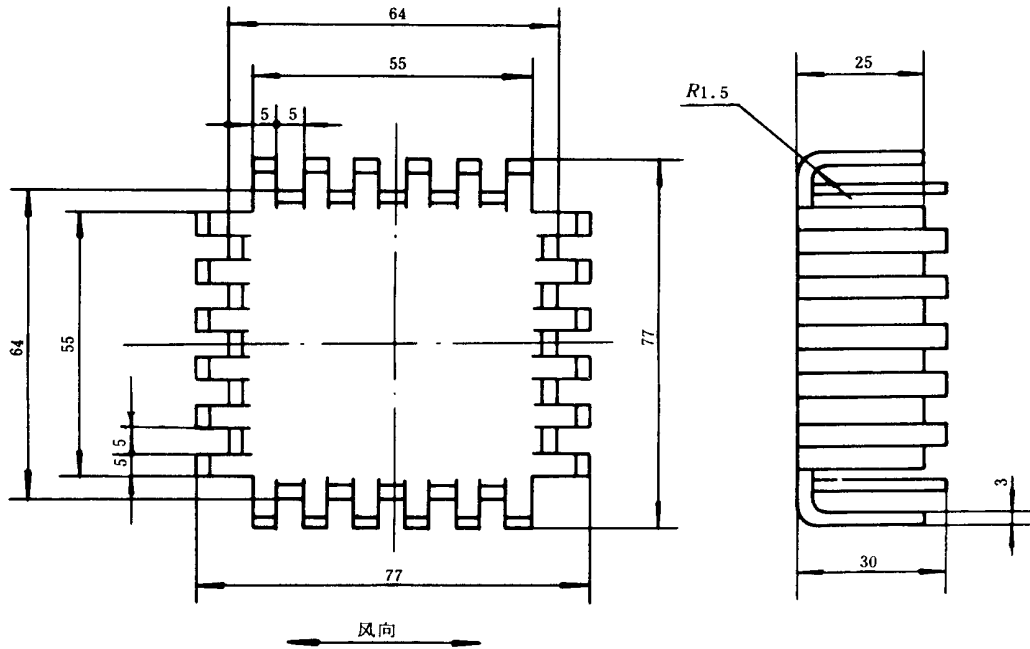
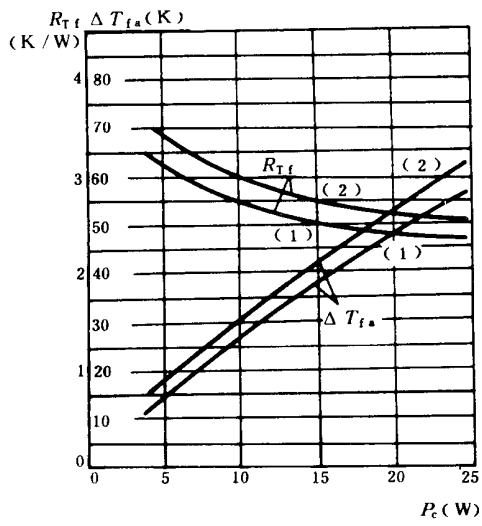
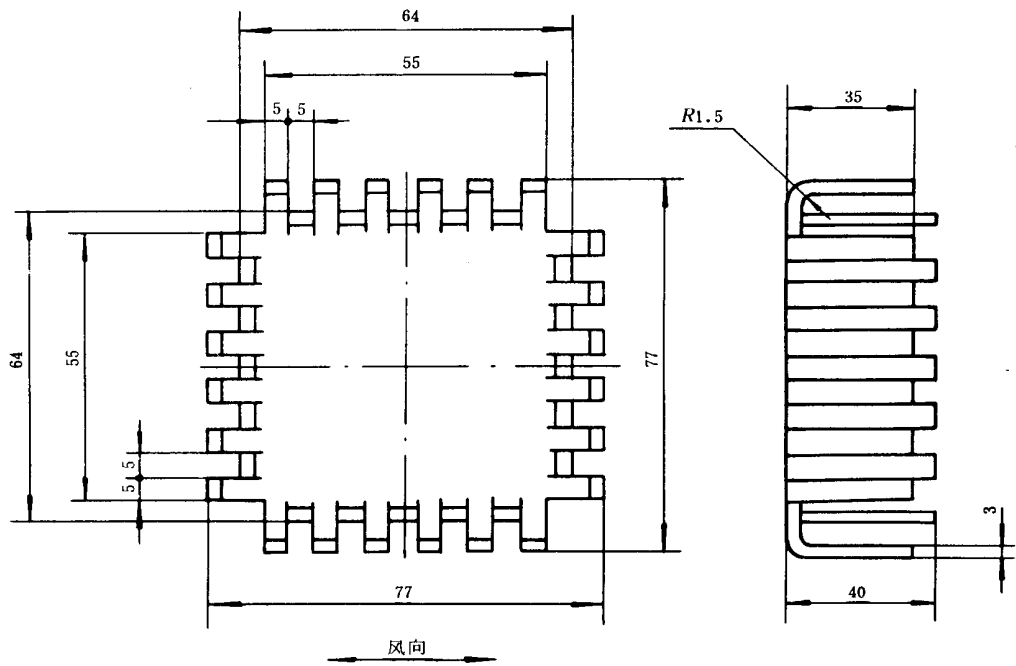
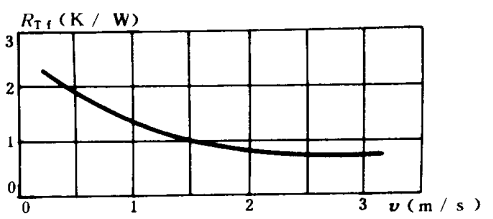
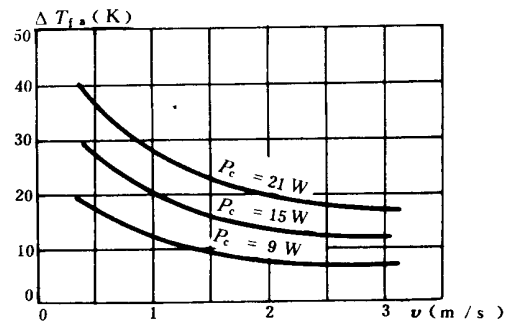

风冷

图 16 SRZ 119
(理论重量96.5克)

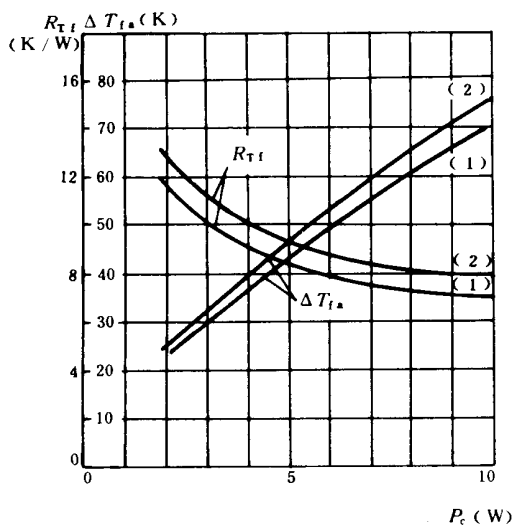
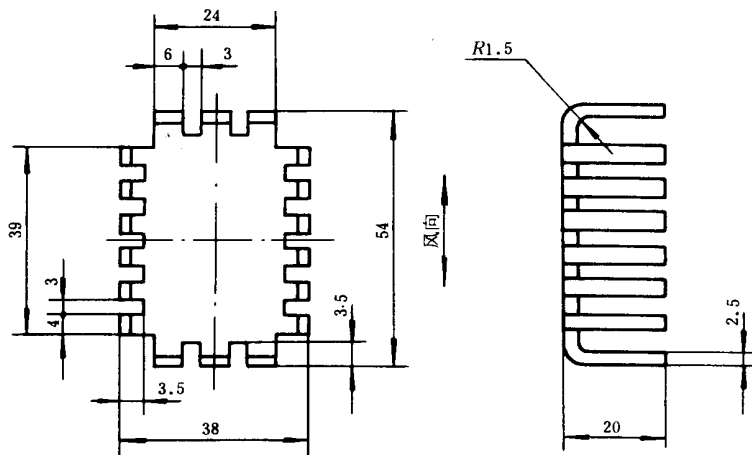

自然冷却

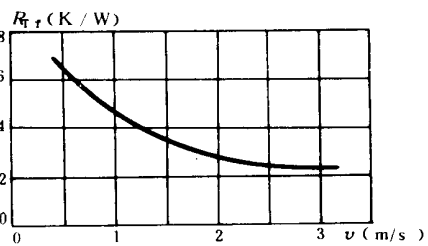
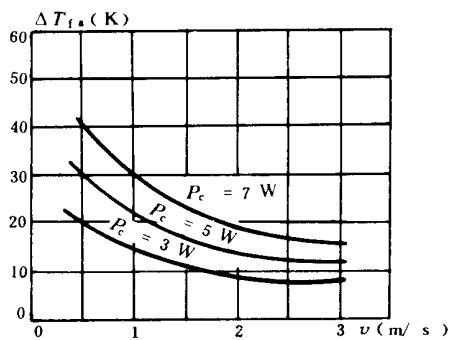

风冷

图 17 SRZ201
(理论重量20.6克)



图 18 SRZ 202
(理论重量45.7克)



图 19 SRZ 203
(理论重量75.1克)

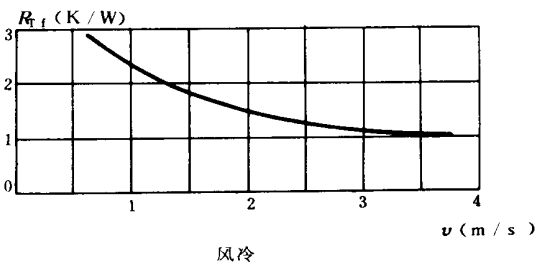
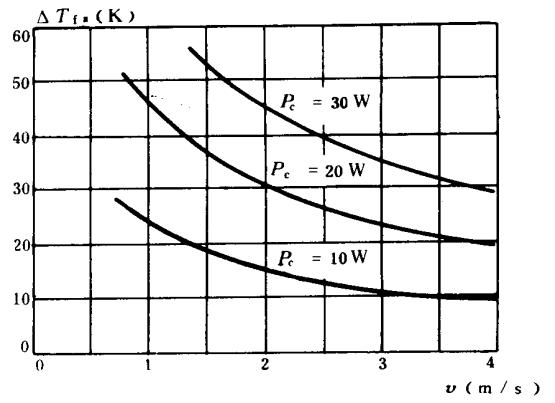
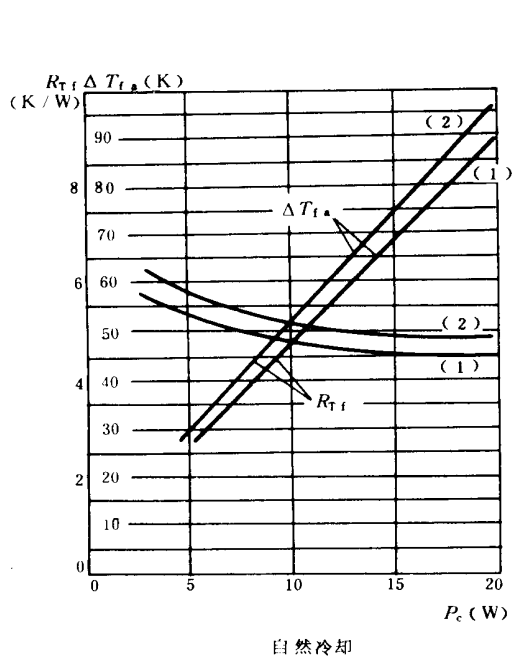
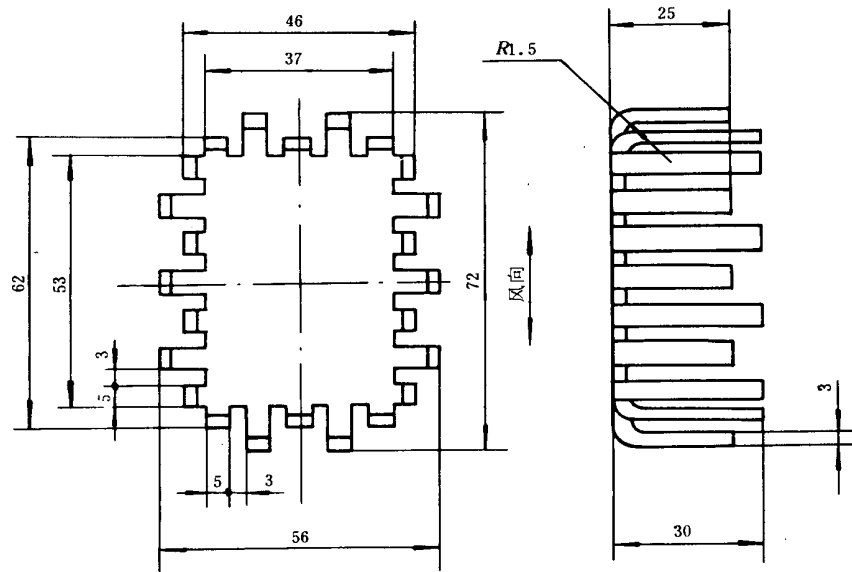

自然冷却

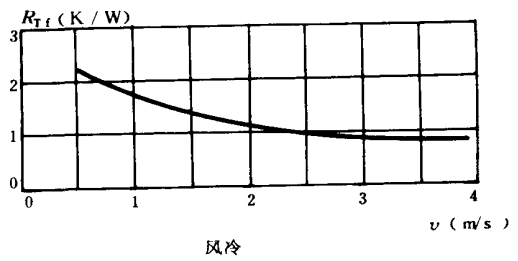
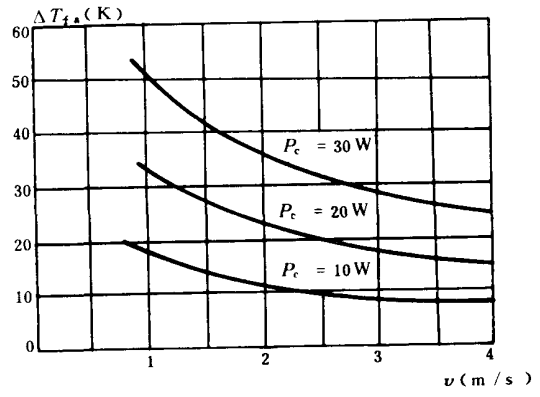
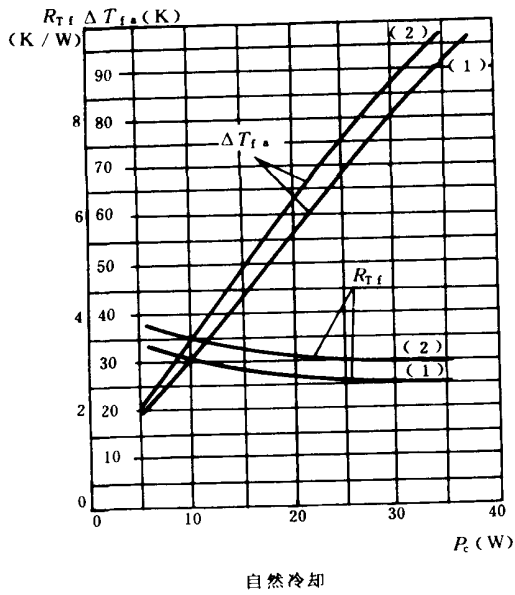
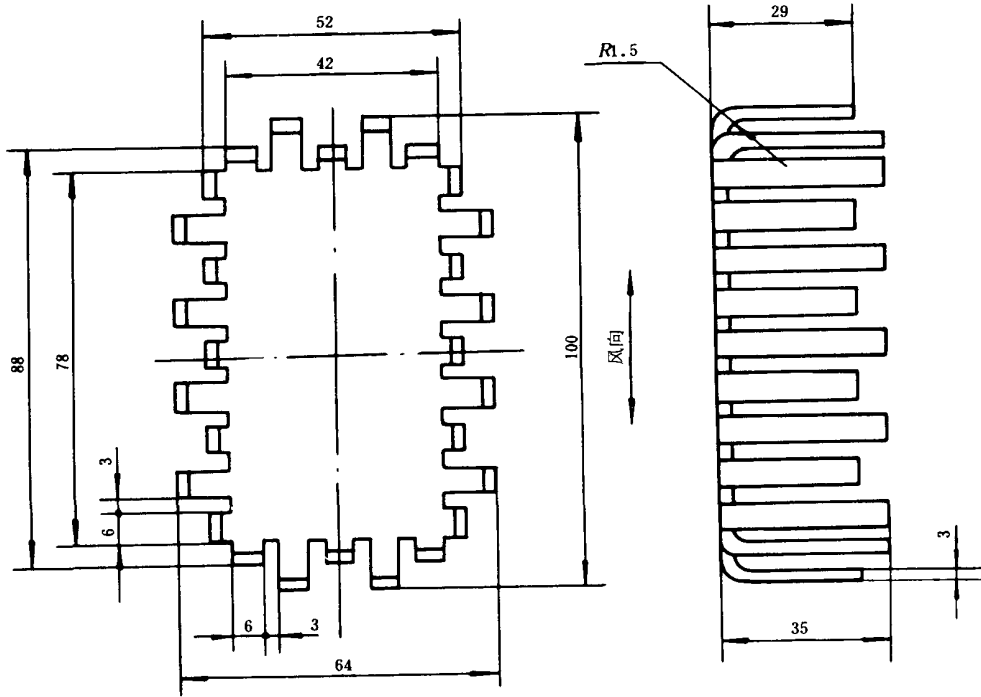
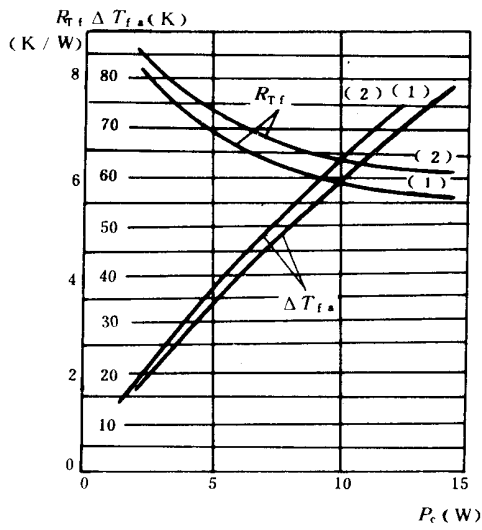
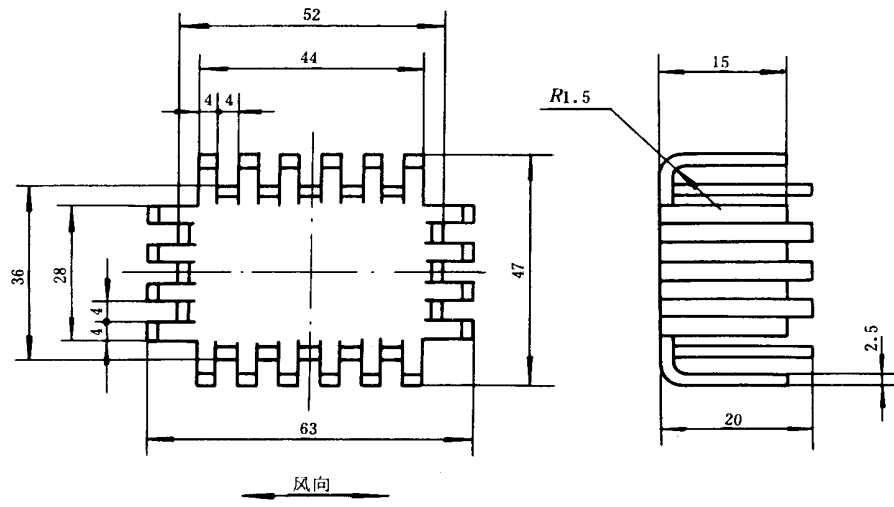
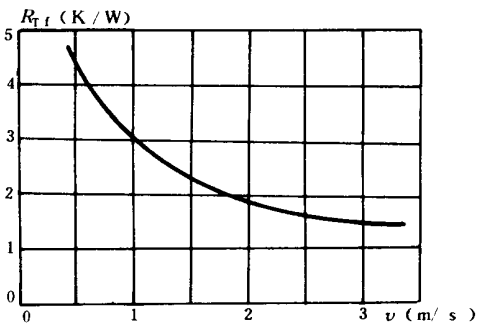
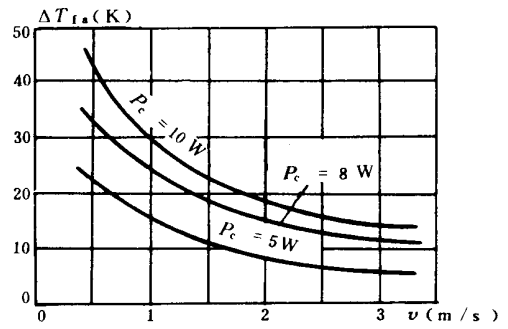

风冷

图 20 SRZ 211
(理论重量28.2克)



图 21 SRZ 212
(理论重量37.9克)



图 22 SRZ 213
(理论重量48.9克)

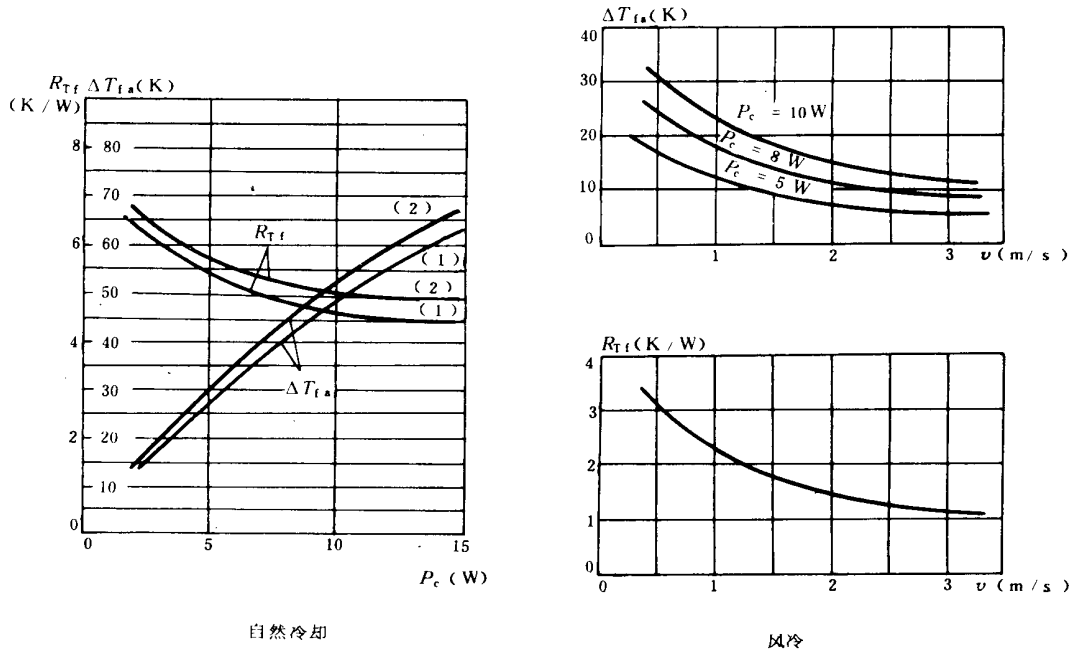
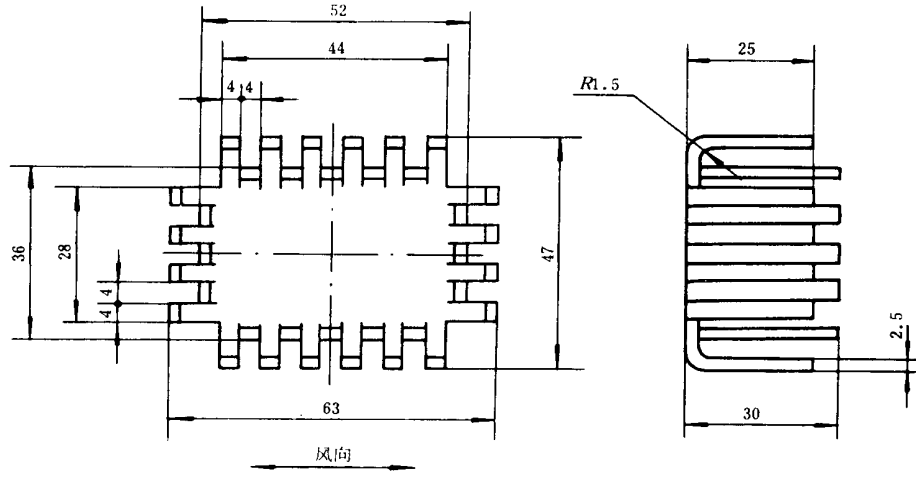

图 23 SRZ 214
(理论重量60.8克)

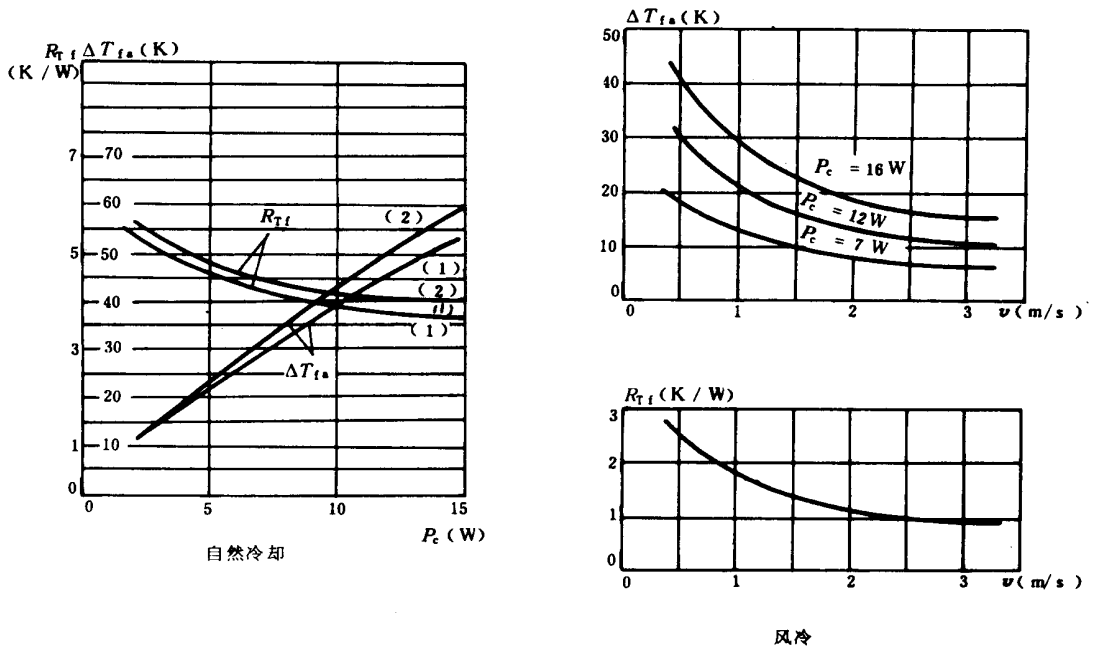
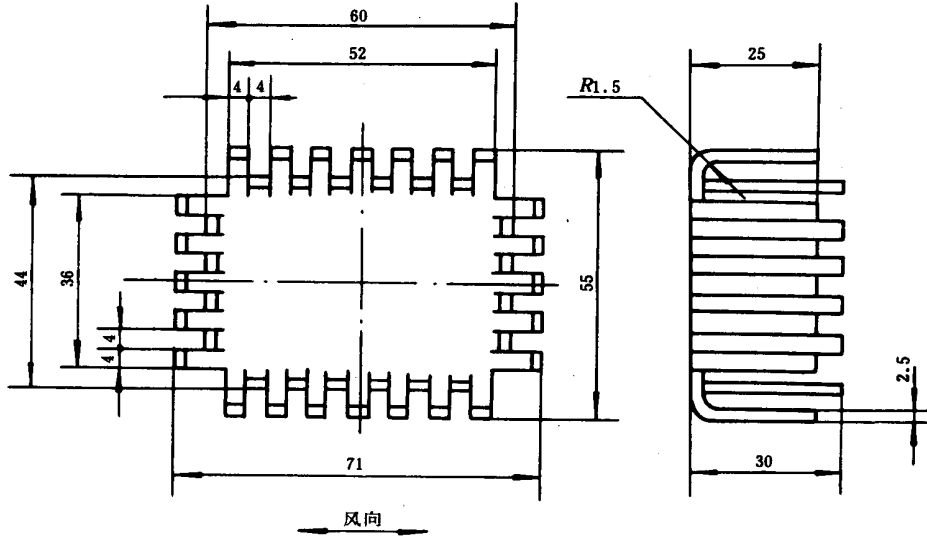

图 24 SRZ 215
(理论重量75.7克)

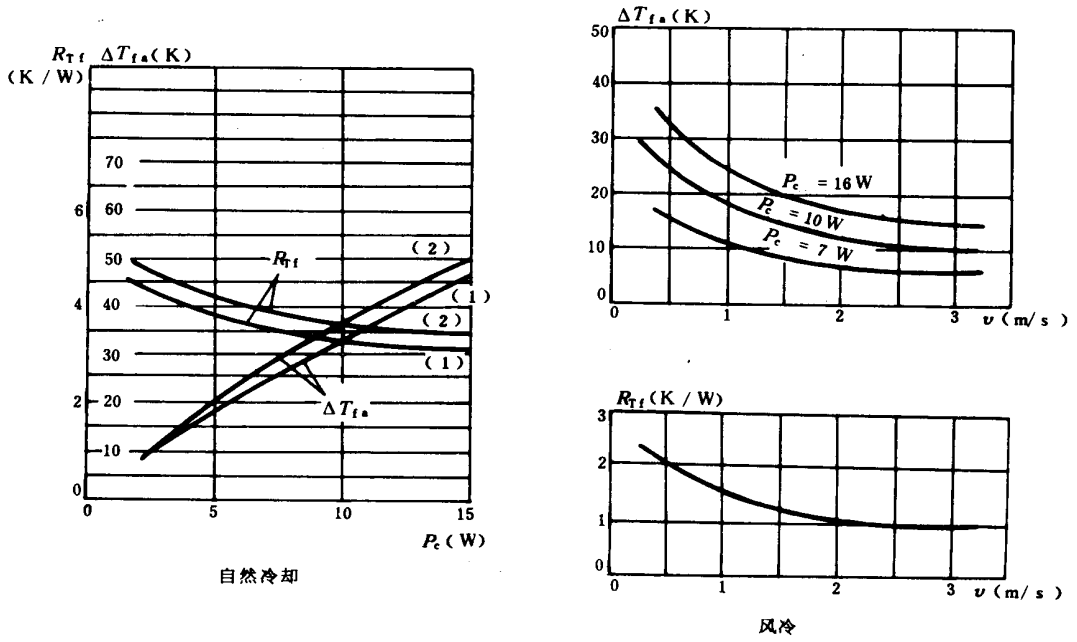
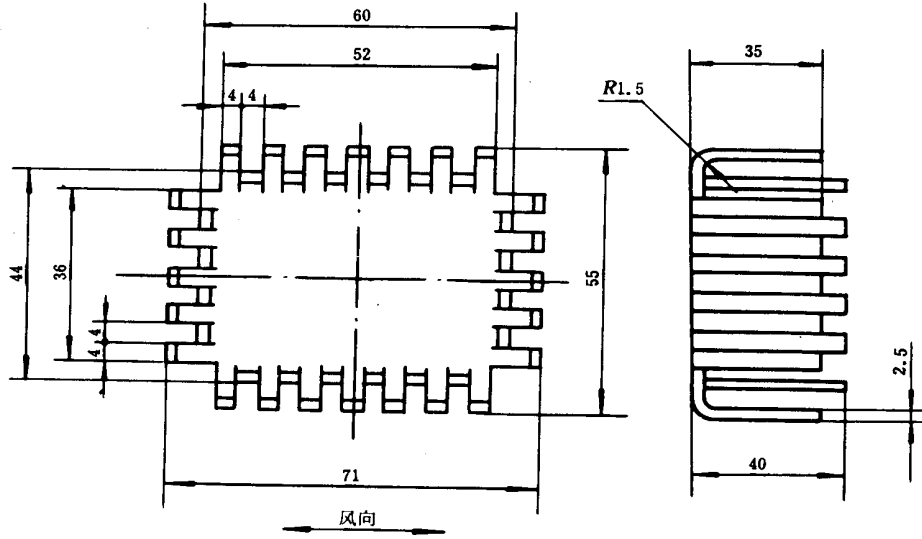

自然冷却

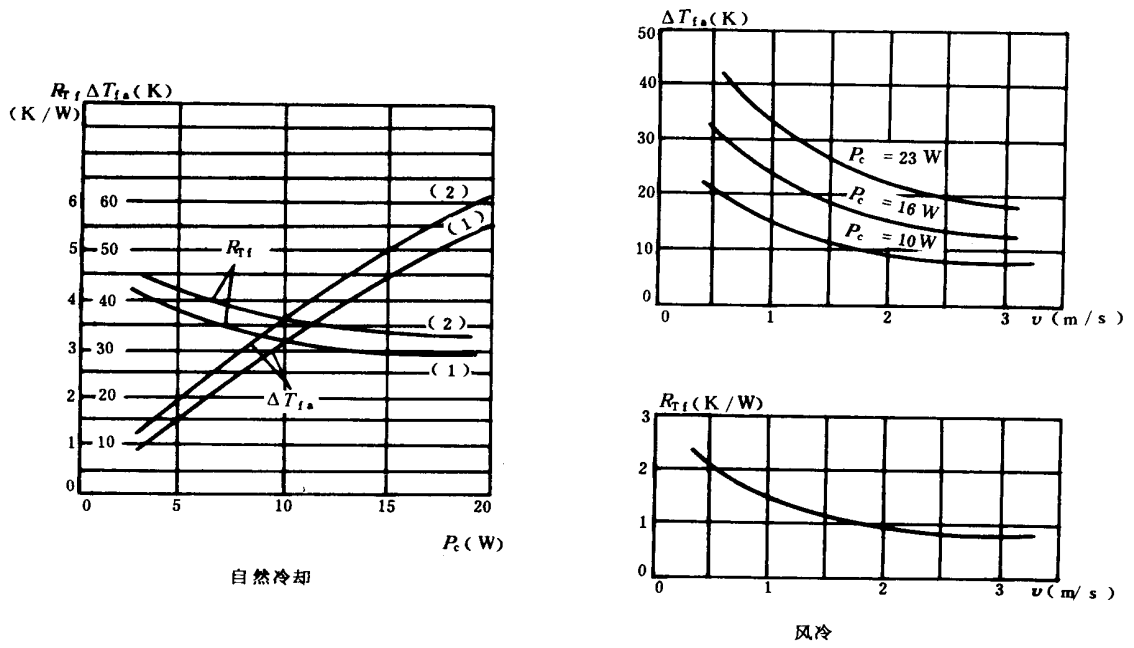
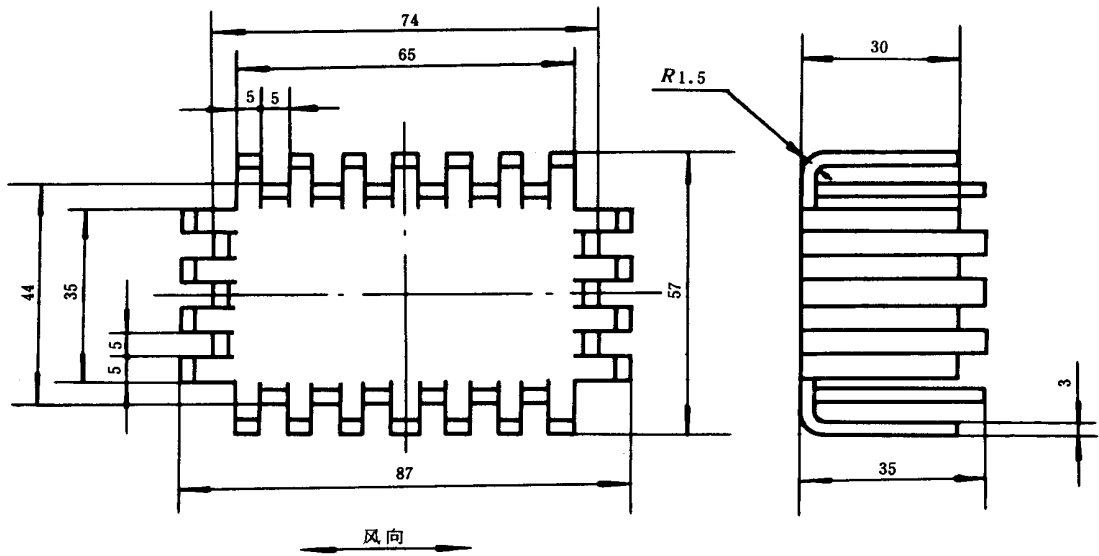
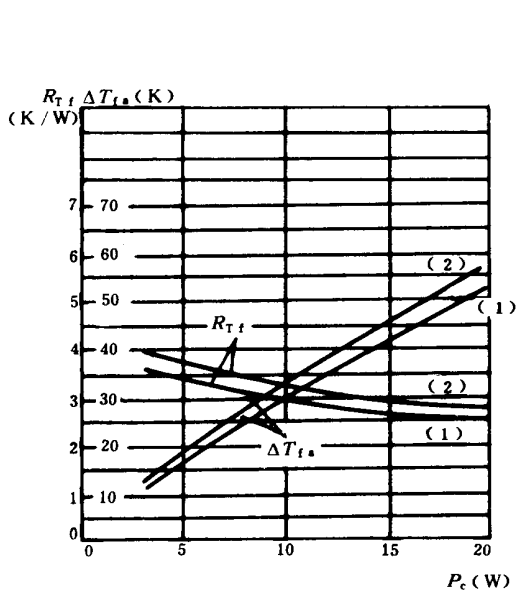
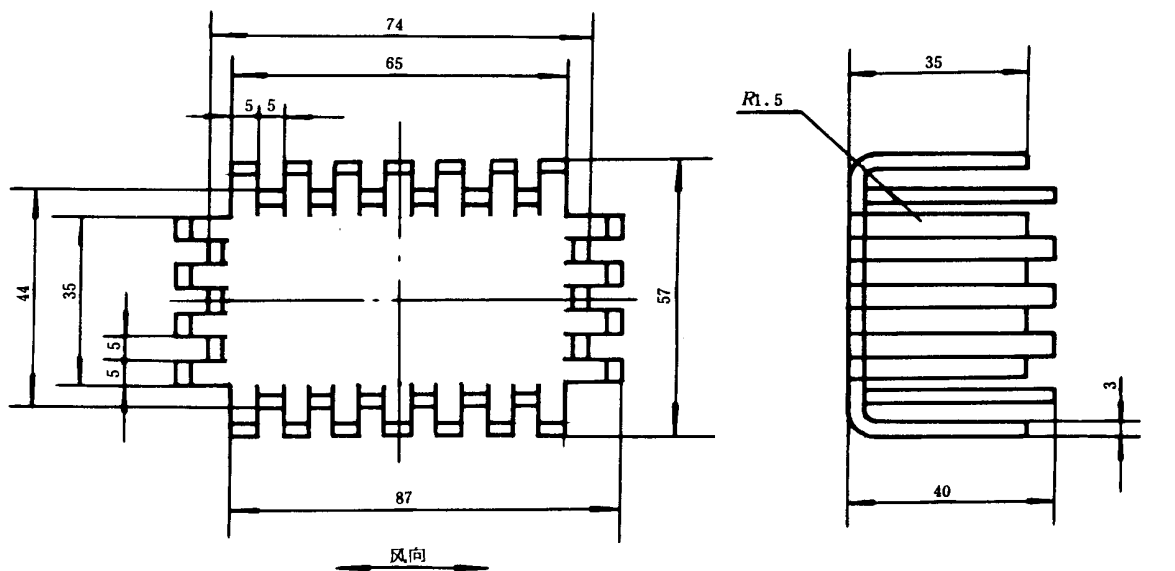
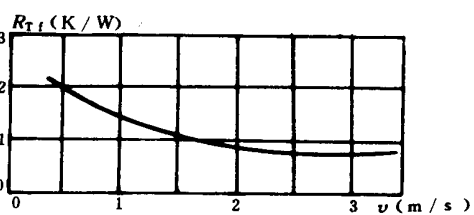
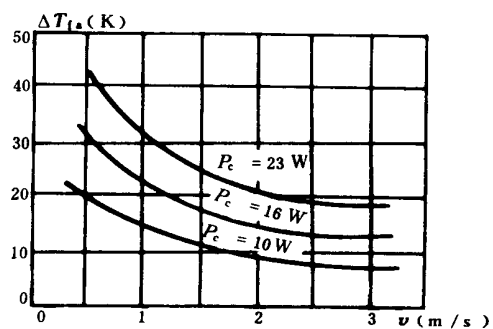

风冷

图 25 SRZ 216
(理论重量83.9克)



图 26 SRZ 217
(理论重量96.1克)



图 27 SRZ 218
(理论重量105.9克)

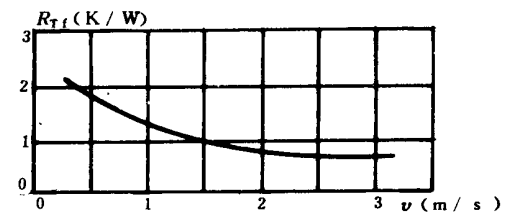
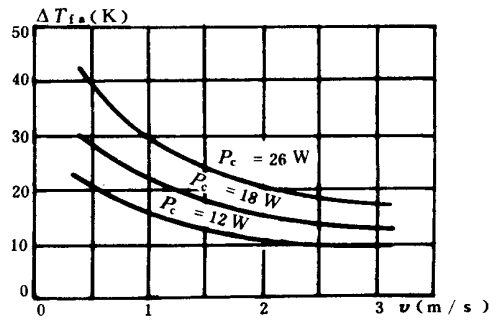
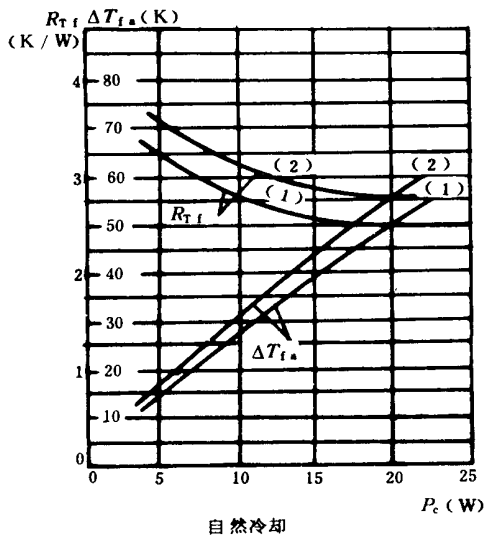
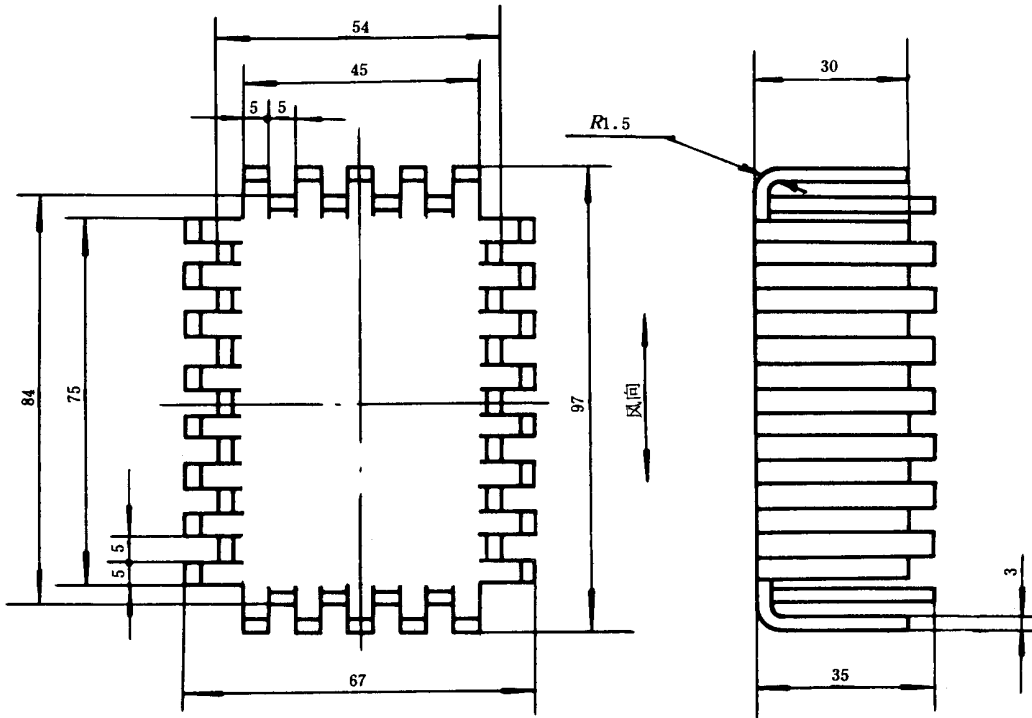

图 28 SRZ 219
(理论重量126.2克)

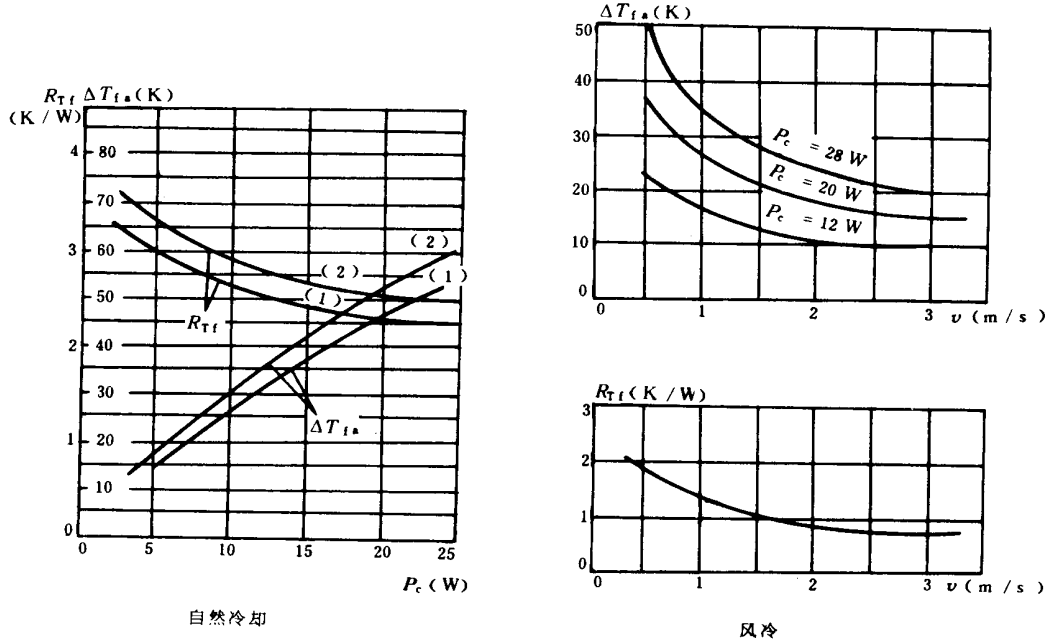
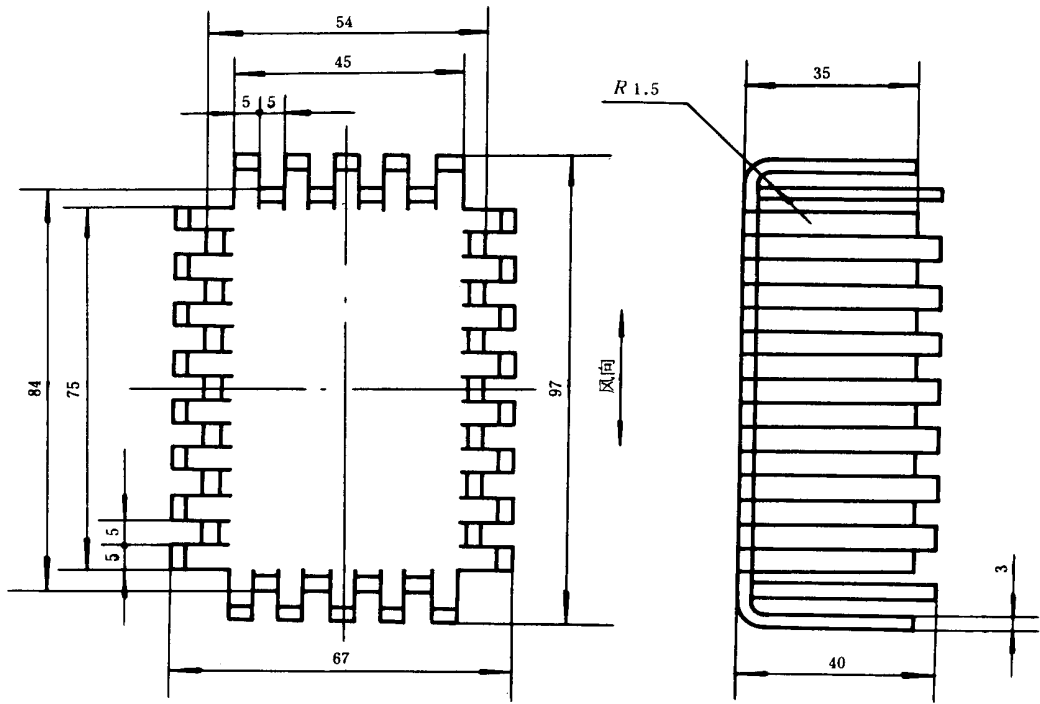

序号	代号	L_1	L_2	L_3	L_4	h_1	h_2	H	备注
1	SRZ 213 (A)	71	55	20	36	25	13	30	
2	SRZ 214 (A)	71	55	20	36	35	17	40	
3	SRZ 215 (A)	87	57	20	35	30	15	35	
4	SRZ 216 (A)	87	57	20	35	35	17	40	
5	SRZ 217 (A)	97	67	30	45	30	15	35	
6	SRZ 218 (A)	97	67	30	45	35	17	40	
7	SRZ 219 (A)	97	67	30	45	45	22	50	

注：“A”型散热器比同序号散热器的热阻大10%。

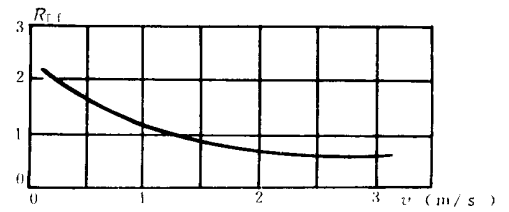
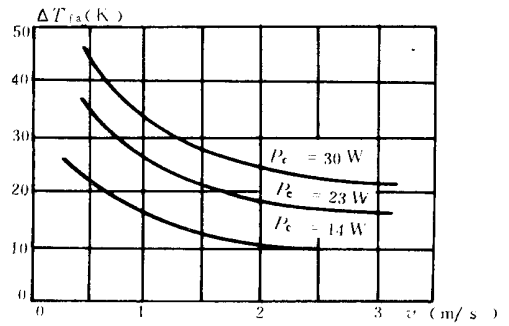
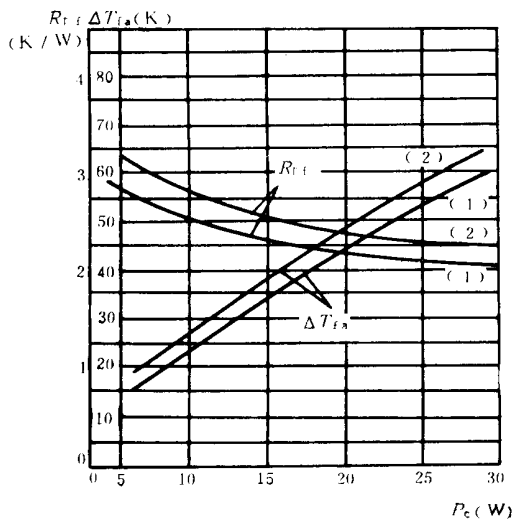
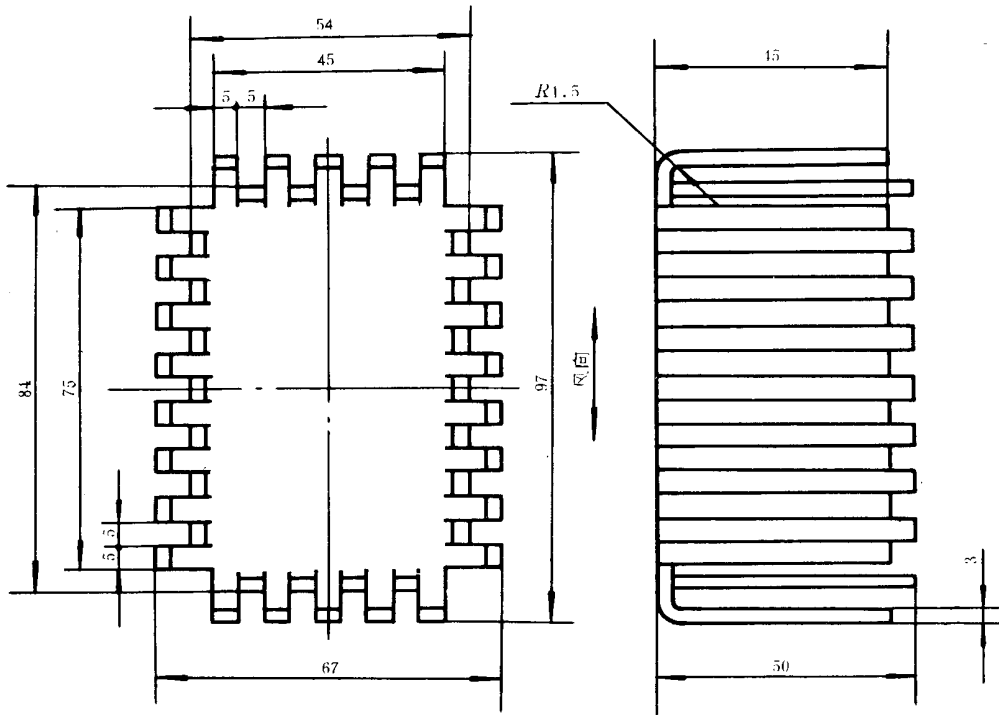
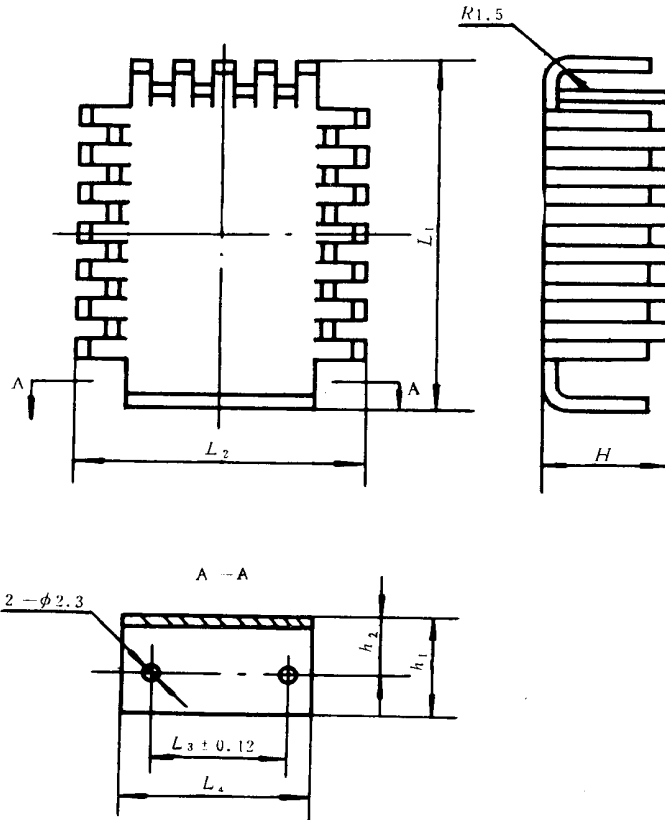
图 29 SRZ 213 (A) ~ SRZ 219 (A)

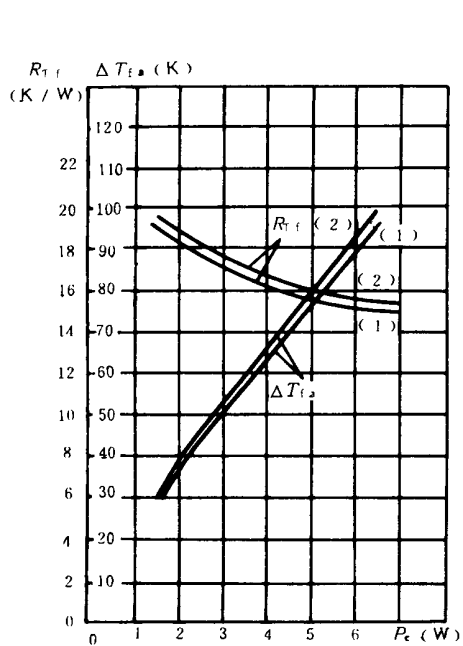
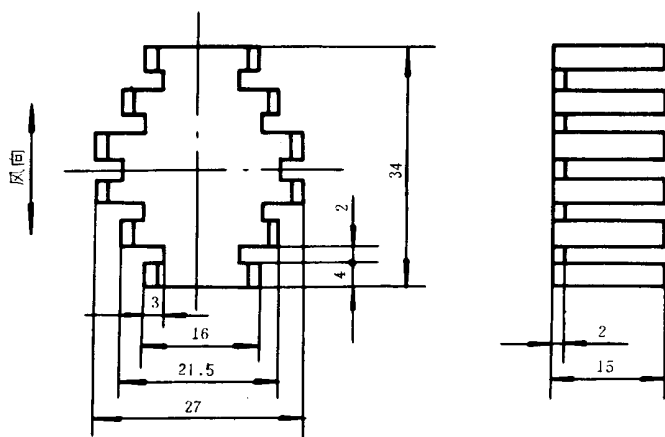

自然冷却

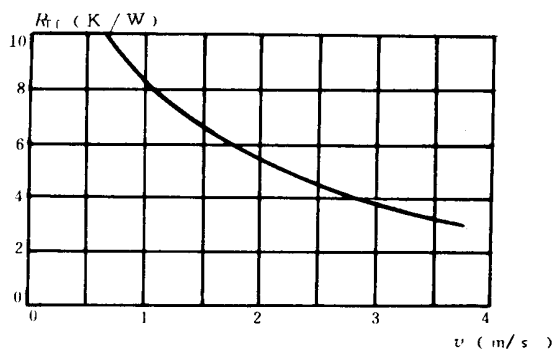
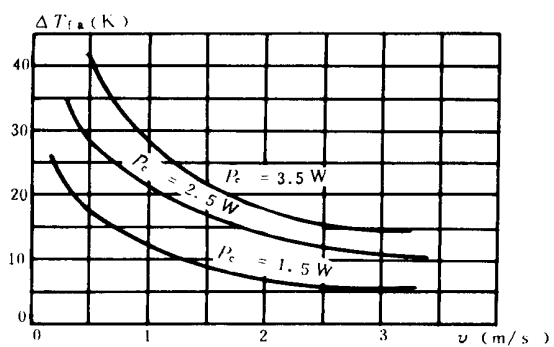

风冷

图 30 SRZ 301
(理论重量6.93克)



图 31 SRZ 302
(理论重量15.9克)



图 32 SRZ 303
(理论重量13.9克)

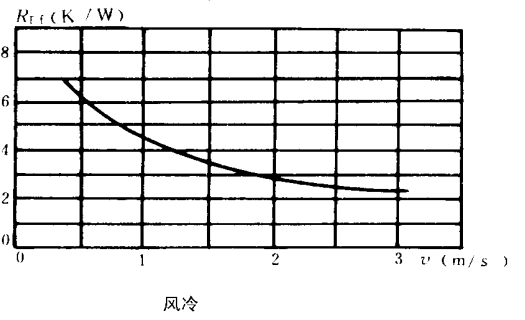
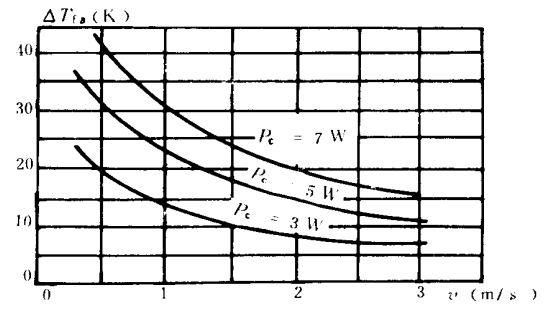
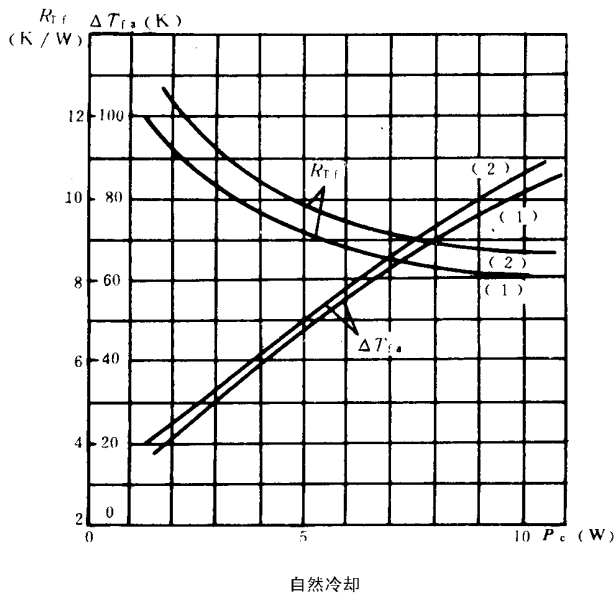
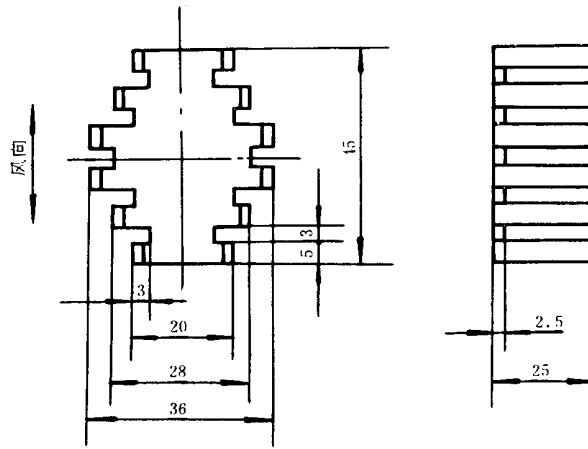

图 33 SRZ 304
(理论重量11.8克)

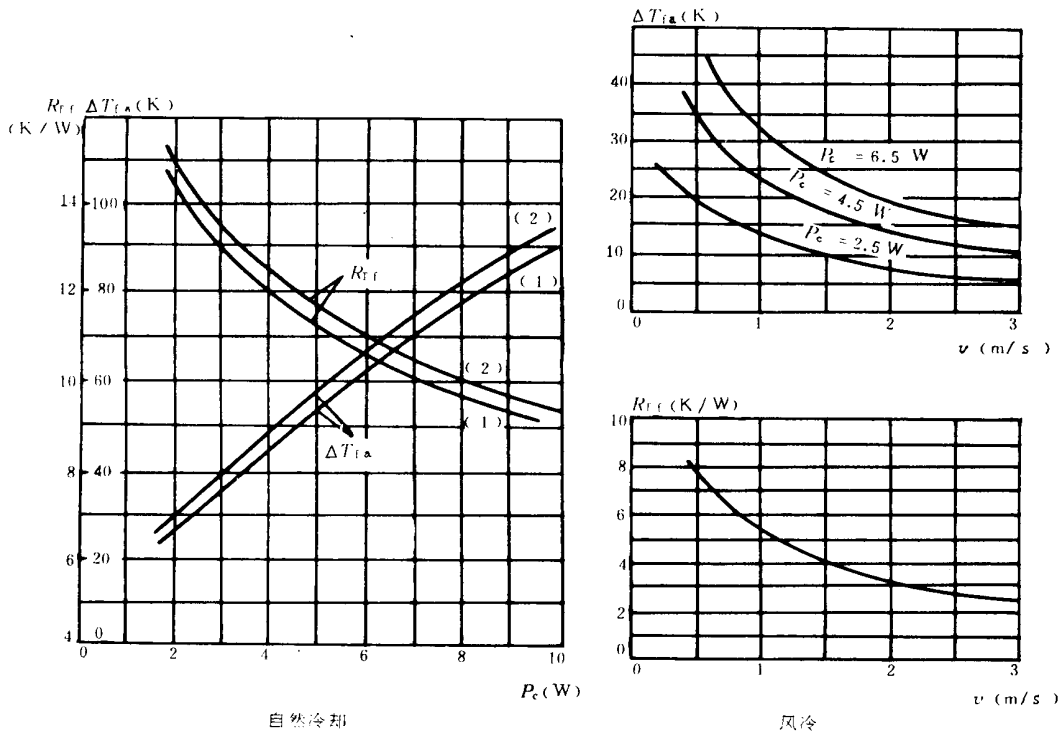
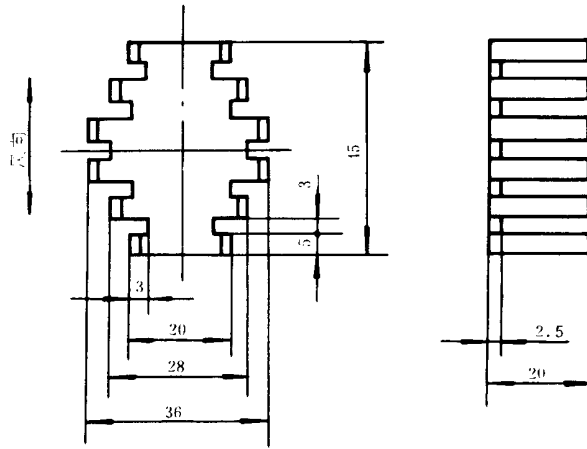

注：折弯内圆角R 1.5。

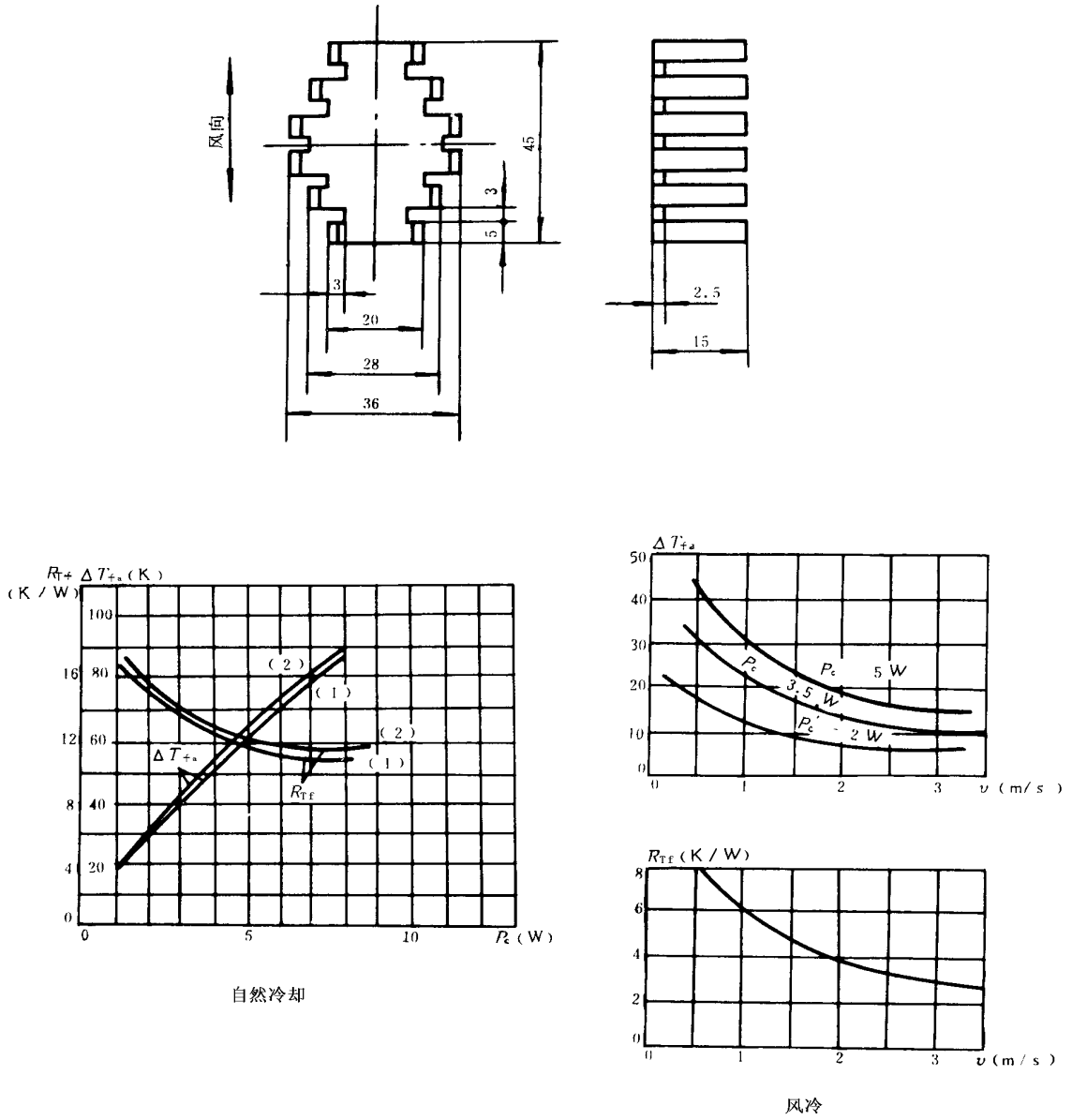
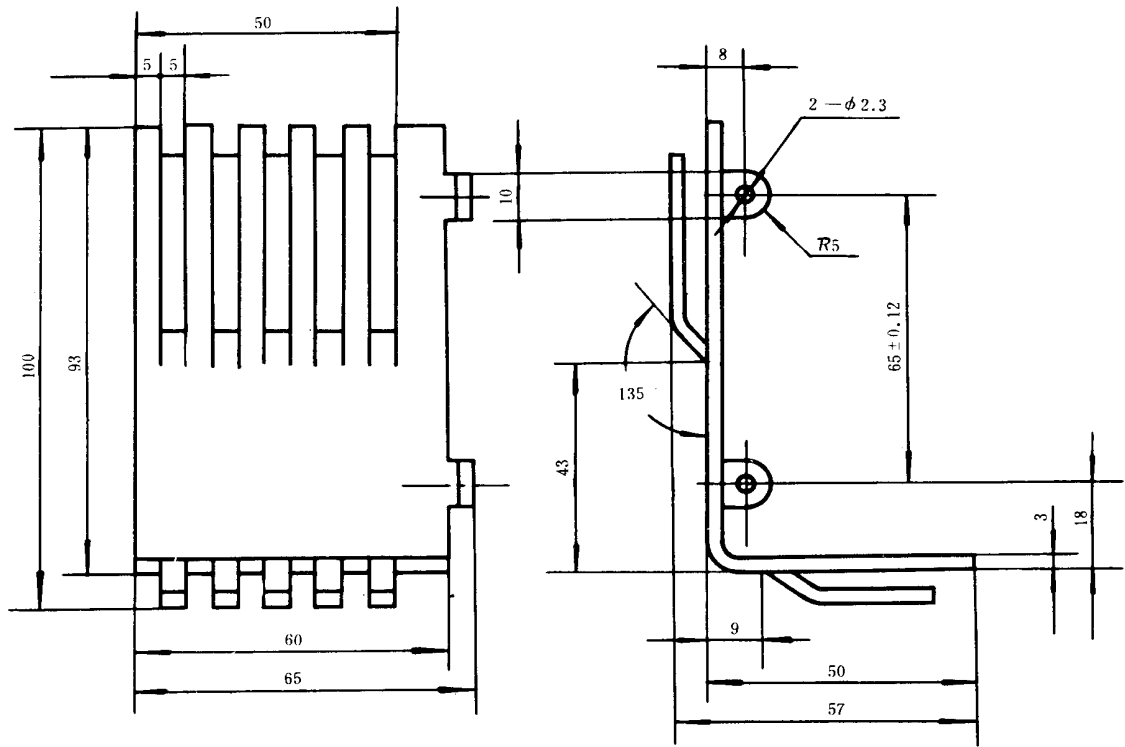

图 34 SRZ 411
(理论重量69.8克)



注：折弯内圆角 $R 1.5$ 。

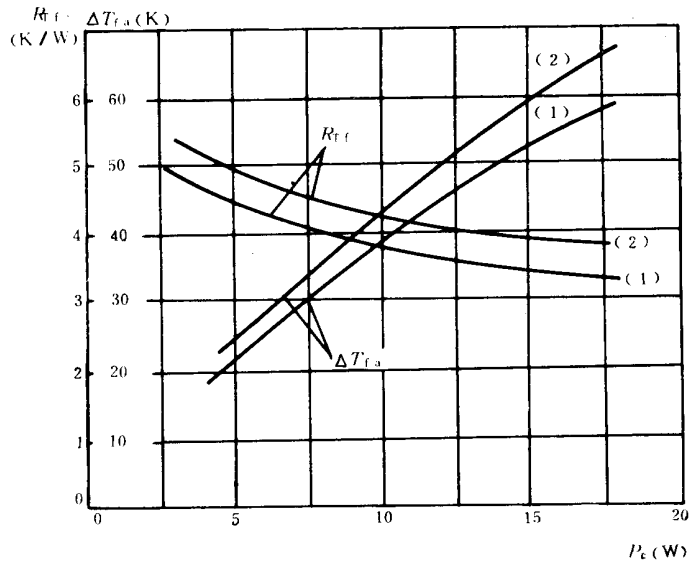
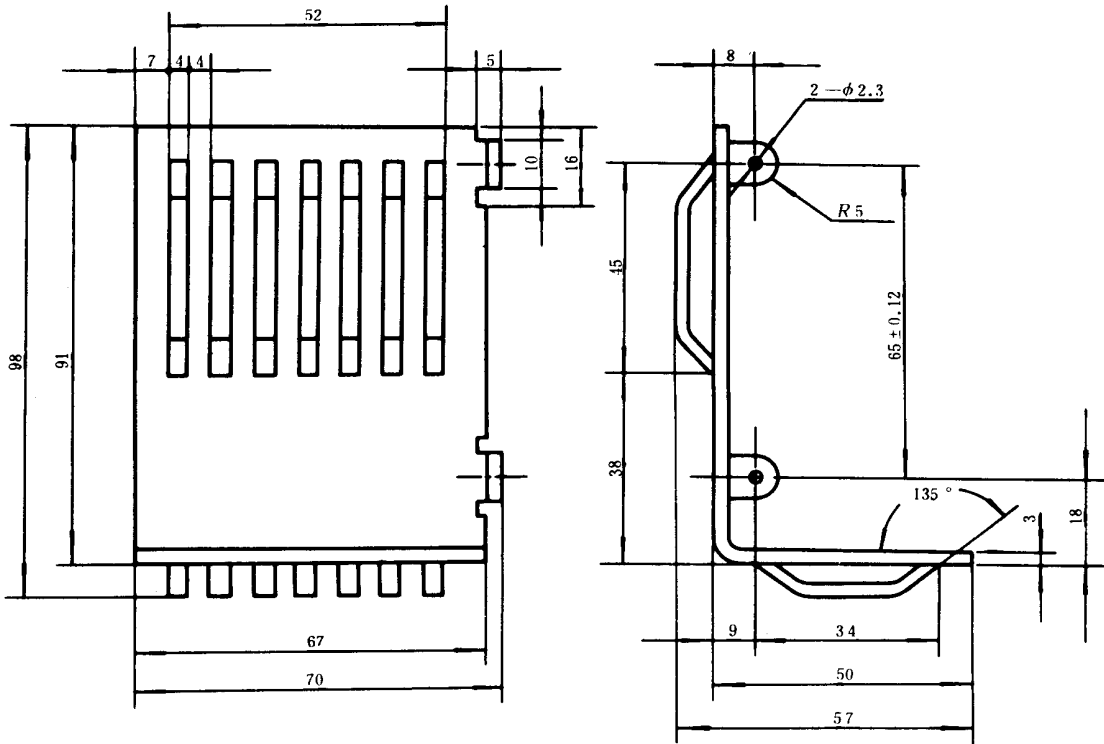

图 35 SRZ412
(理论重量76.3克)

GB 7423.3-87

附加说明:

本标准由中华人民共和国电子工业部提出。

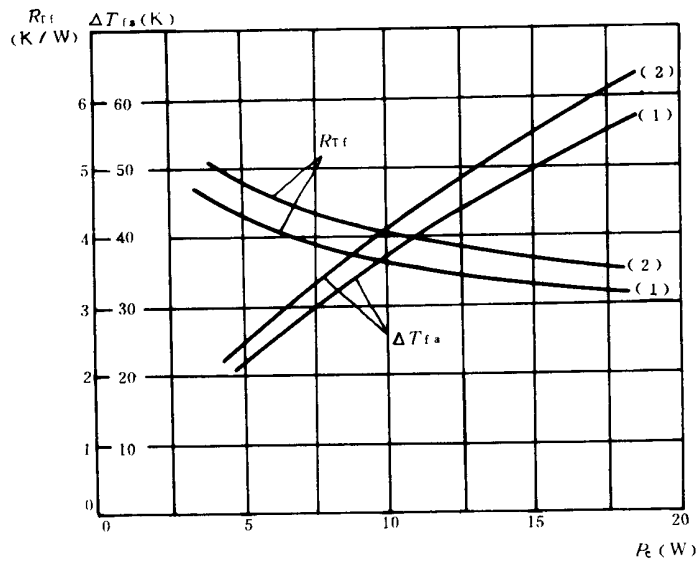
本标准由南京工学院、电子工业部标准化研究所负责起草。

本标准主要起草人谢德仁、邱成悌、曹建华。